

DOOR CATALOGUE

2025



CLASSEN[®]

ADD LIFE TO YOUR INTERIOR





CREATE
an interior
WITH CHARACTER

CLASSEN[®]



YOUR **DOORS**

CONTENTS

SYMBOLS USED IN THE CATALOGUE.....	6	TECHNICAL PANEL DOORS	96
LACQUERED PANEL DOORS	8	NATURA HK/HB.....	98
GLIFA NEW!	10	GUARD.....	100
EVELIN NEW!	12	BORD.....	102
LIRGO.....	14	BORD W3.....	104
BRENTA.....	16	FIRE DOORS EI30 / EI60.....	106
VENIS.....	18	ACOUSTIC DOORS EI30 / 42 DB.....	108
LARIX.....	20	VENOM.....	110
LINEA.....	22	VENOM ALU.....	112
LINEA PREMIUM.....	24	ACOUSTIC DOORS.....	114
LINEA PREMIUM LOFT.....	26	DOORS ALIGNED WITH THE WAL	116
MORANO.....	28	COMPACT.....	118
SALVANO.....	30	SLIDING DOOR SYSTEMS	120
CLASSIC.....	32	DOUBLE LEAF SLIDING SYSTEM.....	122
VENEER FRAME DOORS	34	SINGLE LEAF SLIDING SYSTEM.....	123
SVIN NEW!	36	AERO.....	124
MALIKA NEW!	38	MODI DESIGN.....	126
MAMBA NEW!	40	ECLISSE SLIDING POCKET DOOR SYSTEM.....	127
FORMA NEW!	42	WOOD-BASED DOOR FRAMES	128
ODYN NEW!	44	ADJUSTABLE / ADJUSTABLE 80.....	130
TUMULA NEW!	46	NON-REBATED ADJUSTABLE / ADJUSTABLE 80.....	132
CLIF.....	48	ADJUSTABLE REVERSE 80 NEW!	133
MAGNETIC.....	50	ARCUS.....	134
GRECO.....	52	NEW ARCUS.....	135
HAVANA.....	54	STANDARD 2-PACK FIXED.....	136
LUKKA.....	56	CMOK.....	137
TOSCA.....	58	STEEL DOOR FRAMES	138
KOFANO.....	60	STEEL FIXED REBATED / NON-REBATED.....	139
VENEER PANEL DOORS	62	STEEL ADJUSTABLE.....	140
MODUL.....	64	STEEL ADJUSTABLE NON-REBATED.....	141
DARK.....	66	RECOMMENDED DOOR FRAMES	142
MILK.....	68	BORD STEEL FIXED / CORNER FIXED.....	143
VERTI.....	70	BORD MDF FIXED.....	144
GLAS.....	72	HYBRYDA.....	145
DISCOVERY.....	74	BORD W3 STEEL FIXED.....	146
TETYDA.....	76	GUARD STEEL FIXED / ADJUSTABLE.....	147
NATURA HR.....	78	FIRE WOODEN FIXED / ADJUSTABLE.....	148
ANDROMEDA.....	80	FIRE STEEL FIXED.....	149
DEMETER.....	82	42 DB MDF FIXED REBATED.....	150
CENTURY.....	84	42 DB MDF FIXED NON-REBATED.....	150
MALAGA.....	86	DOOR FRAME ADJUSTMENT SET.....	151
MODENA 4.....	88	THE ABC OF DOORS - INFORMATION DATABASE	152
NATURA.....	90	ADDITIONAL ELEMENTS.....	154
ANTIOPE.....	92	DOOR DIMENSIONS.....	155
SIDE PANEL.....	94	MOULDINGS / RAL COLOURS.....	156
		CROWNS.....	157
		ACCESSORIES.....	158
		HANDLES.....	160
		VENEER.....	166
		HPL UNI DECORS.....	172
		HPL WOOD DECORS.....	173

3
YEARS

WARRANTY
ON CLASSEN
PRODUCTS

SYMBOLS USED IN THE CATALOGUE

— TYPE OF DOORS

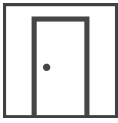

Single leaf doors

The most frequently chosen type of doors, commonly used in construction. Depending on the collection and purpose, leaves with the width from 60 to 120 cm are used. Next to this icon, you will always find the range of available widths for the selected collection.

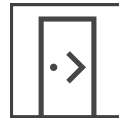

Single leaf sliding doors

To open this door leaf, you need to slide it along a wall; it can also disappear completely into the wall cavity. There are several types of sliding systems available, so you can choose the one that suits your needs and interior design. Sliding doors are only available with a straight, non-rebated edge.



Double leaf doors

A type of door used for very wide door openings. Depending on the collection and purpose, the total width of both leaves from 120 to 200 cm is used. Active and passive leaf available only in rebated version. Next to this icon, you will always find the range of available widths for the selected collection.

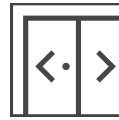

Double leaf sliding doors

Two door leaves used in case of very wide door openings. There are two types of sliding systems available, so you can choose the one that suits your needs and interior design - either the on-wall or the pocket door system. Sliding doors are only available with a straight, non-rebated edge.

— TYPE OF DOOR REBATE



Hard Edge Rewers

A rebate used in reverse doors. Such a combination makes it possible to install doors that open inwards, while maintaining the effect of flush between the door leaf and the door frame on the outside.



Hard Edge B

A straight edge of a non-rebated door, timeless, aesthetic and durable. This solution increases the visual value, because the door creates a uniform surface with the door frame.



Hard Edge R

Aesthetically rounded edge with the radius of 5 mm for veneered doors and 2 mm for lacquered doors. This practical solution guarantees not only safety to our children, but also easier maintenance.

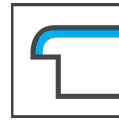

Hard Edge PF

The rounded edge of the door leaf with a radius of 4 mm, finished with flexible CPL laminates, obtained thanks to the modern technology of boards refinement - postforming. Characteristic features - abrasion resistance and safety.



Hard Edge K

Widely used, aesthetically executed edge with K rebate profile is a standard finishing of a door leaf edge. K edge profile is stylish and always in fashion.

— DOOR CONSTRUCTION AND FILLING



Classen Hard

Reinforced peripheral frame, consisting of two construction elements: a peripheral frame made of softwood / MDF, filled with a highly specialized cardboard. This solution guarantees increased rigidity of a door leaf and resistance against warping.

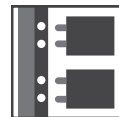

Framed construction

It consists of single elements, made entirely of wood-based material - MDF, covered with Classen decors, joined together with the use of solid mounting pins.

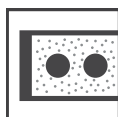

Perforated chipboard

Construction consisting of a wood-based perforated chipboard placed between a peripheral frame made of softwood / MDF. Such construction of a door leaf guarantees high stability and increased sound absorption.

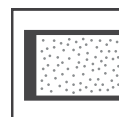

Chipboard

Construction consisting of a solid chipboard placed between a peripheral frame made of softwood / MDF. Such construction of a door leaf guarantees a high stability and very good sound absorption.



Honeycomb

It is a highly specialized cardboard with a construction and structure similar to honeycomb, used as a standard stabilizing filling between construction/peripheral frame of a door leaf.



HLT chipboard, acoustic

Construction consisting of a solid chipboard with increased acoustic parameters, placed between a peripheral frame made of softwood and a plywood.

— TECHNICAL PROPERTIES



Burglary resistance

Internal entrance doors, fulfilling the requirements of RC2 anti-burglary protection class, provide better security for your flat.



Mechanical resistance class 3

Door leaves with increased mechanical strength, especially recommended for use in buildings with high traffic, e.g. in public utility, industrial and warehouse buildings. Recommended for kindergartens, schools and hospitals.

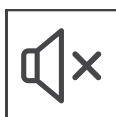

Acoustic resistance

Doors with increased acoustic resistance. A guarantee of full comfort and freedom of action.

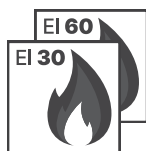

EI30, EI60 fire doors

Fire doors designed for use in residential housing, public utility and collective residential buildings as internal entrance doors. Thickness of a door leaf: 50 mm (for EI 30) and 60 mm (for EI 60).

— DOOR FINISHES



Primo

A basic group of wood veneers, impregnated, characterised by a required abrasion resistance.



CPL

Laminate characterized by very high scratch and abrasion resistance, composed of four layers subject to the process of hot press lamination with the use of special glues, covered with scratch resistant overlay lacquer. Main advantages include particularly high scratch and abrasion, high temperatures, UV and chemical resistance.

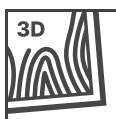

3D Look

Veneers with synchronous pores effect. The pores synchronized with the woodgrain pattern optically emboss it, which leads to creation of a three-dimensional effect. These decors perfectly imitate natural veneer.



HPL

Decorative laminate, 0.8 mm thick, based on thermosetting resins. Created of several layers, which are composed of melamine decorative papers and one or more resin-impregnated reinforcing papers. They are characterized by a very high resistance to both chemical agents and mechanical damage.



Iridium

Laminate characterized by high scratch and abrasion resistance, created in the process of hot press lamination with the use of special glues, covered with scratch resistant overlay lacquer. Main advantages include particularly high scratch and abrasion, chemical and UV resistance as well as high aesthetic value achieved due to the possibility of applying wood structure.



PU lacquer

Smooth satin HDF surface coated with polyurethane lacquer. Our standard offer includes collections in RAL 9003 White, RAL 7004 Grey, RAL 9005 Black, and Cashmere NCS 2005. Other colours from the RAL palette (table on page 171) are available only in this lacquer quality.



UV lacquer

HDF surface covered with primer and ecological lacquer hardened with UV rays. Standard white Lac colour is an equivalent of RAL 9003. HDF surface covered with primer and ecological lacquer hardened with UV rays. Standard white Lac colour is an equivalent of RAL 9003.



UV Pure lacquer

HDF surface coated with eco-friendly lacquer and polyurethane primer, which creates a velvety smooth surface of the door leaf. Standard white Lac colour is an equivalent of RAL 9003.



RAL palette colours

A possibility to finish the door in colours from the RAL palette as an extra-cost option, details in the table on page 171. Minimum order quantity - 3 sets (door leaf + door frame). All collections in RAL are finished in polyurethane lacquer quality.

— Other

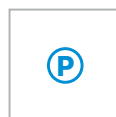

Rebated door leaf

Supplementary marking to the above icons, indicating the type of rebate that is available with a given type of door.

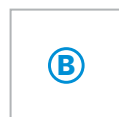

Non-rebated door leaf

Supplementary marking to the above icons, indicating the type of rebate that is available with a given type of door.



LACQUERED PANEL DOORS

LACQUERED PANEL DOORS

A perfect combination of modern design and high-quality workmanship. In our collections, they most often appear in the colour of timeless white, which makes them a great means to enlarge the interior optically. The minimalism of decorations gives them an elegant character. The surface of the leaves finished with lacquer is perfectly smooth. The doors are easy to clean and maintain. They are also distinguished by high durability and resistance to damage, which makes them a good investment for years.



DO YOU PREFER SIMPLICITY AND MONOCHROMATIC COLOURS? You will find them in lacquered doors with a minimalist design. Thanks to them, you will emphasize the elegant and subdued character of your flat.

DO YOU LOVE VIVID COLOURS? Do you feel that they express your personality? Don't give up on them! Lacquered doors will harmonize beautifully with even the craziest palette of colours, while introducing balance in the interior design.

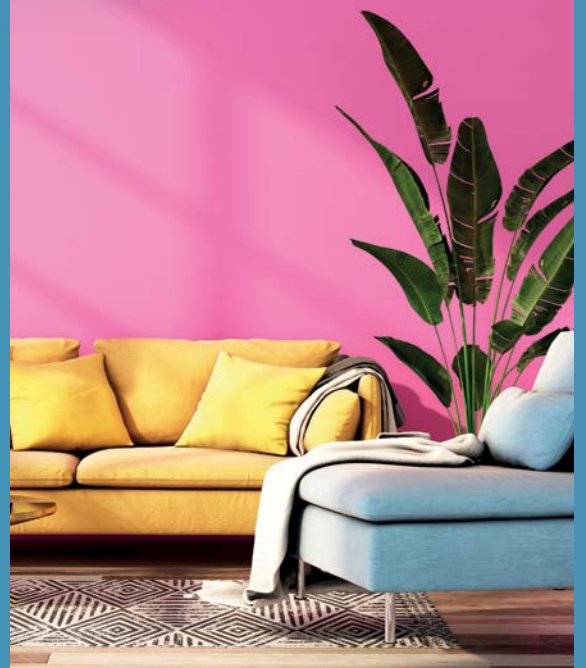

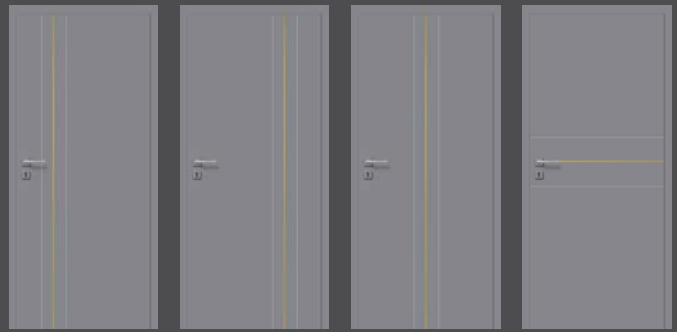

model 1z

model 2z

model 3z

model 4z

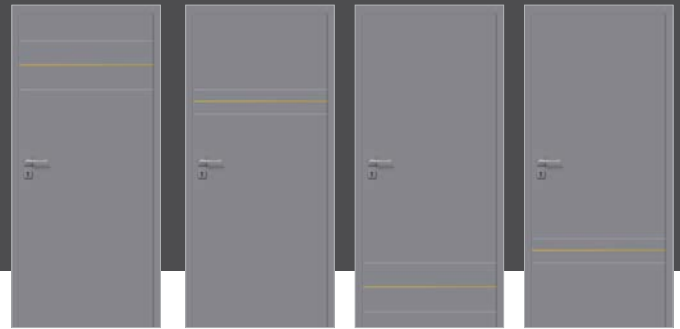

model 5z

model 6z

model 7z

model 8z

DETAILS



new slim profile of the R2 rebate, for rebated doors



round groove profile, width: 8 mm



aluminium profile a - alu 8 mm



aluminium profile z - gold 8 mm



aluminium profile c - black 8 mm

EXPLANATION OF MODEL DESCRIPTIONS:

a – aluminium profile
z – gold aluminium profile
c – black aluminium profile

UV Pure lacquer PU lacquer



9003 WHITE



NCS 2005 CASHMERE



7004 GREY



9005 BLACK



AVAILABLE IN RAL PALETTE ¹

EXTRA-COST OPTIONS:

Ventilation undercut / recuperation 15 mm

Reverse door leaf

Non-rebated / passive / sliding door leaf

Third hinge (non-rebated door)

Third hinge (reverse door)

Size 100'

RAL colours

EVELIN

NEW!

LACQUERED PANEL DOORS REBATED / NON-REBATED / REVERSE



DOOR SPECIFICATION

- peripheral frame made of MDF board, reinforced with plywood, stabilizing "honeycomb" core

Rebated door leaf:

- new slim profile of the R2 rebate
- two silver screw-in pintle hinges
- lock: standard key lock / bathroom lock / cylinder lock / mortise lock ²

Non-rebated / reverse door leaf: ³

- two openings for 3D hidden hinges
- magnetic lock: standard key lock / bathroom lock / cylinder lock / mortise lock

RECOMMENDED DOOR FRAMES

Hard edge K:

- standard fixed and adjustable door frame, lacquered: UV White or PU Cashmere, Grey and Black

Hard edge B / Rewers:

- adjustable non-rebated or reverse lacquered door frame: UV White or PU Cashmere, Grey and Black

¹ | Minimum order quantity in the case of RAL colour finish - 3 sets (door leaf + door frame).

² | For RAL 9005 Black, black locks.

³ | For RAL 9005 Black, black locks. Black hinges only in the set with the door frame in 9005 Black lacquer.



model 1

model 2

model 3

model 4

model 5

model 6



model 7

model 8

model 9

model 10

model 11

model 12

DETAILS



new slim profile of the R2 rebate, for rebated doors



two groove profiles, straight - width: 20 mm, round - width: 8 mm

UV Pure lacquer



9003 WHITE

PU lacquer



NCS 2005 CASHMERE



7004 GREY



9005 BLACK



AVAILABLE IN RAL PALETTE ¹

EXTRA-COST OPTIONS:

Ventilation undercut / recuperation 15 mm

Perforated chipboard

Reverse door leaf

Non-rebated / passive / sliding door leaf

Third hinge (rebated door)

Third hinge (non-rebated door)

Third hinge (reverse door)

Size 100'

RAL colours

LIRGO

LACQUERED PANEL DOORS REBATED / NON-REBATED / REVERSE

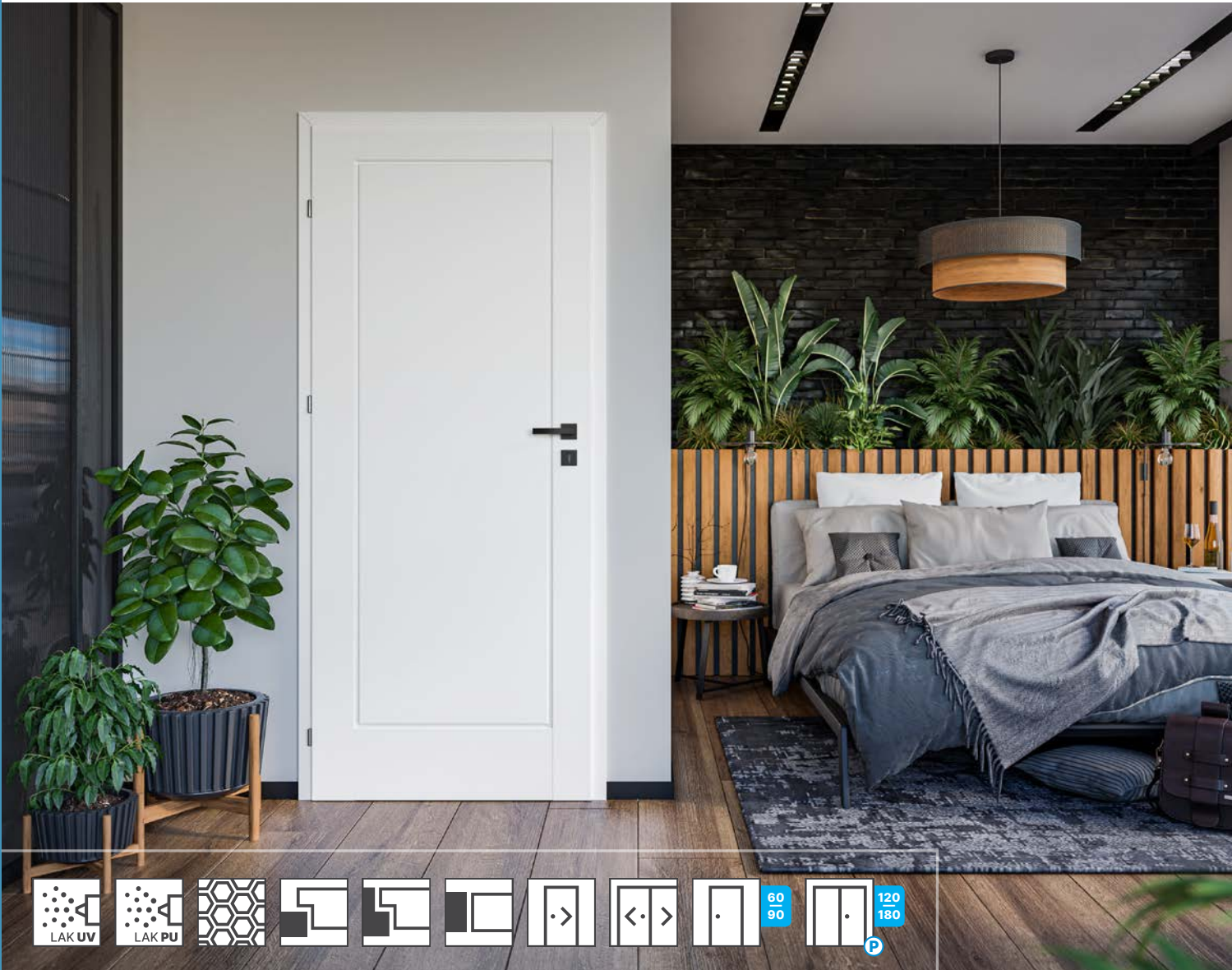

DOOR SPECIFICATION

- peripheral frame made of MDF board, reinforced with plywood, stabilizing "honeycomb" core

Rebated door leaf:

- two silver screw-in pintle hinges
- lock: standard key lock / bathroom lock / cylinder lock / mortise lock ²

Non-rebated / reverse door leaf: ³

- two openings for 3D hidden hinges
- magnetic lock: standard key lock / bathroom lock / cylinder lock / mortise lock

RECOMMENDED DOOR FRAMES

Hard edge K:

- standard fixed and adjustable door frame, lacquered: UV White or PU Grey and Black

Hard edge B / Rewers:

- adjustable non-rebated or reverse lacquered door frame: UV White or PU Grey and Black

¹ | Minimum order quantity in the case of RAL colour finish - 3 sets (door leaf + door frame).

² | For RAL 9005 Black, black locks.

³ | For RAL 9005 Black, black locks. Black hinges only in the set with the door frame in 9005 Black lacquer.



full - UV white



full - PU grey



full - PU black

DETAILS



groove profile - white



groove profile - grey



groove profile - black

UV lacquer



9003 WHITE

PU lacquer



7004 GREY



9005 BLACK



AVAILABLE IN RAL PALETTE ¹

EXTRA-COST OPTIONS:

Ventilation undercut / recuperation 15 mm

Reverse door leaf

Non-rebated / passive / sliding door leaf

Third hinge (rebated door)

Third hinge (non-rebated door)

Third hinge (reverse door)

RAL colours

BRENTA

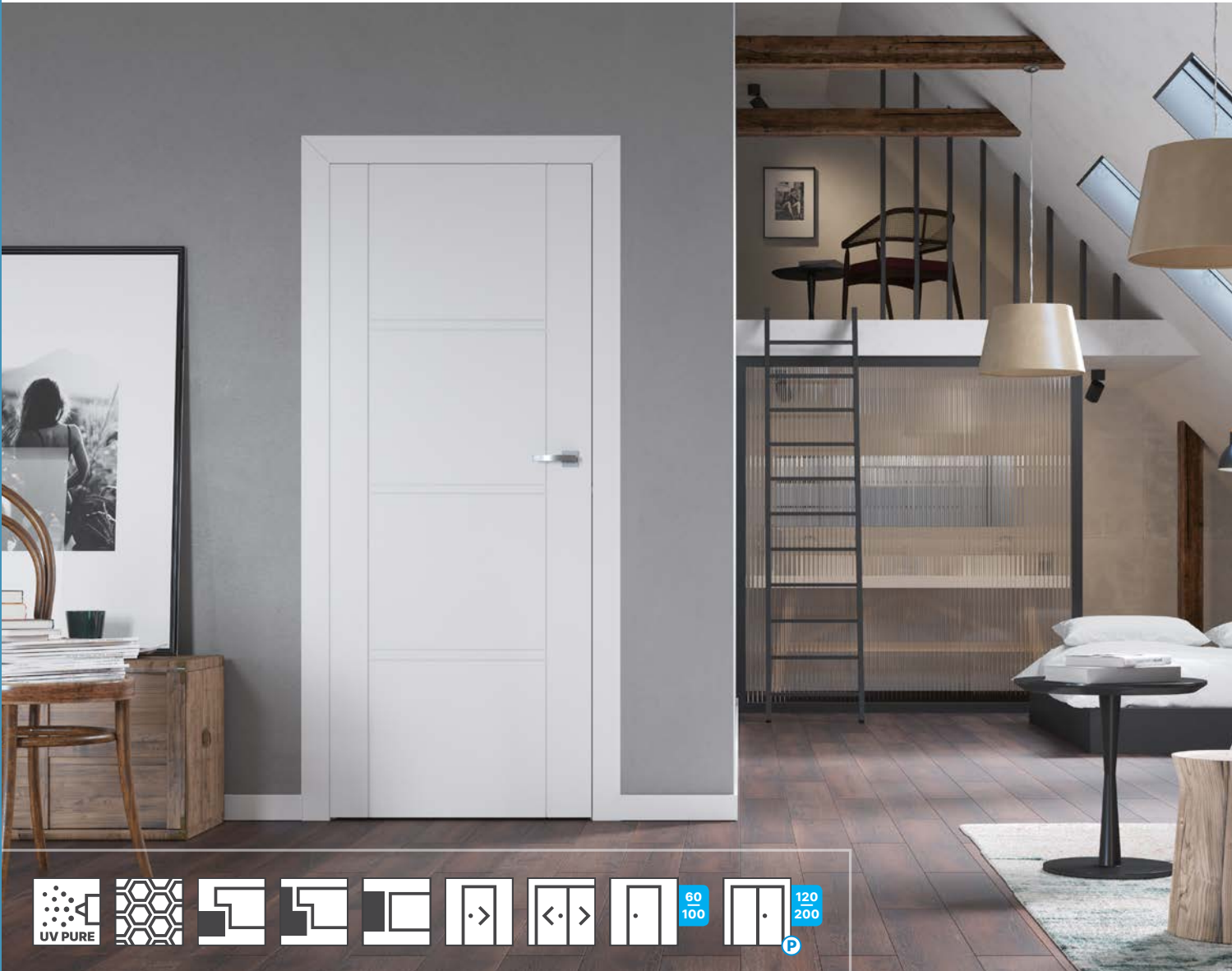

DOOR SPECIFICATION

- peripheral frame made of MDF board, reinforced with plywood, stabilizing "honeycomb" core

Rebated door leaf:

- two silver screw-in pintle hinges ¹
- lock: standard key lock / bathroom lock / cylinder lock / mortise lock

Non-rebated / reverse door leaf:

- two openings for 3D hidden hinges
- magnetic lock: standard key lock / bathroom lock / cylinder lock / mortise lock

RECOMMENDED DOOR FRAMES

Hard edge K:

- standard fixed and adjustable door frame, UV lacquered

Hard edge B:

- non-rebated adjustable or UV lacquered reverse door frame

¹ | Door leaves 100' and reinforced door leaves regardless of the size - the set includes 3 hinges.

² | Minimum order quantity in the case of RAL colour finish - 3 sets (door leaf + door frame).



model 1

model 2

model 3

model 4



model 5

model 6

model 7

model 8

DETAILS



sharp groove
profile, width:
3 mm

UV Pure lacquer



9003 WHITE



AVAILABLE IN RAL
PALETTE ²

EXTRA-COST OPTIONS:

Ventilation undercut / recuperation 15 mm

Perforated chipboard

Reverse door leaf

Non-rebated / passive / sliding door leaf

Third hinge (rebated door)

Third hinge (non-rebated door)

Third hinge (reverse door)

Size 100'

RAL colours

VENIS



DOOR SPECIFICATION

- peripheral frame made of MDF board, reinforced with plywood, stabilizing "honeycomb" core
- milky-white toughened safety glass with anoverprint
- veneered glazing frame

Rebated door leaf:

- two silver screw-in pintle hinges ¹
- lock: standard key lock / bathroom lock / cylinder lock / mortise lock

Non-rebated / reverse door leaf:

- two openings for 3D hidden hinges
- magnetic lock: standard key lock / bathroom lock / cylinder lock / mortise lock

RECOMMENDED DOOR FRAMES

Hard edge K:

- standard fixed and adjustable door frame, UV lacquered

Hard edge B:

- non-rebated adjustable or UV lacquered reverse door frame

¹ | Door leaves 100' and reinforced door leaves regardless of the size - the set includes 3 hinges.

² | Minimum order quantity in the case of RAL colour finish - 3 sets (door leaf + door frame).



model 1



model 2



model 3



model 4

DETAILS



straight groove profiles, width: 10 mm and 20 mm



glazing frame



milky-white toughened safety glass with anoverprint

UV Pure lacquer



9003 WHITE



AVAILABLE IN RAL PALETTE ²

EXTRA-COST OPTIONS:

Ventilation undercut / recuperation 15 mm

Perforated chipboard

Reverse door leaf

Non-rebated / passive / sliding door leaf

Third hinge (rebated door)

Third hinge (non-rebated door)

Third hinge (reverse door)

Size 100'

RAL colours

LARIX



DOOR SPECIFICATION

- peripheral frame made of MDF board, reinforced with plywood, perforated chipboard core
- inlay: alu, gold and black aluminium profile, width: 8 mm, aligned with the door leaf surface

Rebated door leaf:

- three silver screw-in pintle hinges
- lock: standard key lock / bathroom lock / cylinder lock / mortise lock

Non-rebated / reverse door leaf:

- two openings for 3D hidden hinges
- magnetic lock: standard key lock / bathroom lock / cylinder lock / mortise lock

RECOMMENDED DOOR FRAMES

Hard edge K:

- standard fixed and adjustable door frame, UV lacquered

Hard edge B:

- non-rebated adjustable or UV lacquered reverse door frame

¹ | Minimum order quantity in the case of RAL colour finish - 3 sets (door leaf + door frame).



model 1a



model 2a



model 3a



model 4a



model 5a



model 6a



model 7a



aluminium profile
a - alu 8 mm



aluminium profile
z - gold 8 mm



aluminium profile
c - black 8 mm

EXPLANATION OF MODEL DESCRIPTIONS:

- a – aluminium profile
- z – gold aluminium profile
- c – black aluminium profile

UV Pure lacquer

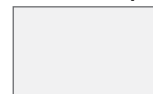

9003 WHITE



AVAILABLE IN RAL
PALETTE ¹

EXTRA-COST OPTIONS:

Ventilation undercut / recuperation 15 mm

Reverse door leaf

Non-rebated / passive / sliding door leaf

Third hinge (non-rebated door)

Third hinge (reverse door)

Size 100'

RAL colours

LINEA



DOOR SPECIFICATION

- peripheral frame made of MDF board, reinforced with plywood, stabilizing "honeycomb" core
- satin glass (models 1.5, 1.6) and milky-white toughened safety glass (models 1.2, 1.3)
- veneered glazing frame

Rebated door leaf:

- two silver screw-in pintle hinges ²
- lock: standard key lock / bathroom lock / cylinder lock / mortise lock

Non-rebated / reverse door leaf:

- two openings for 3D hidden hinges
- magnetic lock: standard key lock / bathroom lock / cylinder lock / mortise lock

RECOMMENDED DOOR FRAMES

Hard edge K:

- standard fixed and adjustable door frame, UV lacquered

Hard edge B:

- non-rebated adjustable or UV lacquered reverse door frame

- ¹ | Model 1.2 – tempered frosted glass with horizontal, transparent strips.
- ² | Door leaves 100' and reinforced door leaves regardless of the size - the set includes 3 hinges.
- ³ | Minimum order quantity in the case of RAL colour finish - 3 sets (door leaf + door frame).



DETAILS



glazing frame



satin glass
(models 1.5, 1.6)



milky-white
toughened safety
glass for models
1.2 and 1.3



straight groove
profile, width:
10 mm

Lacquer UV



9003 WHITE



AVAILABLE IN RAL
PALETTE ²

EXTRA-COST OPTIONS:

Ventilation undercut / recuperation 15 mm

Perforated chipboard

Reverse door leaf

Non-rebated / passive / sliding door leaf

Third hinge (rebated door)

Third hinge (non-rebated door)

Third hinge (reverse door)

Size 100'

RAL colours

LINEA PREMIUM



DOOR SPECIFICATION

- peripheral frame made of MDF board, reinforced with plywood, stabilizing "honeycomb" core

Rebated door leaf:

- two silver screw-in pintle hinges ¹
- lock: standard key lock / bathroom lock / cylinder lock / mortise lock

Non-rebated / reverse door leaf:

- two openings for 3D hidden hinges
- magnetic lock: standard key lock / bathroom lock / cylinder lock / mortise lock

RECOMMENDED DOOR FRAMES

Hard edge K:

- standard fixed and adjustable door frame, UV lacquered

Hard edge B:

- non-rebated adjustable or UV lacquered reverse door frame

¹ | Door leaves 100' and reinforced door leaves regardless of the size - the set includes 3 hinges.

² | Minimum order quantity in the case of RAL colour finish - 3 sets (door leaf + door frame).



model 1

model 2

model 3

model 4



model 5

model 10
(smooth)

model 11

DETAILS



round groove
profile, width: 8 mm

UV Pure lacquer

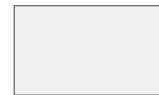

9003 WHITE



AVAILABLE IN RAL
PALETTE ²

EXTRA-COST OPTIONS:

Ventilation undercut / recuperation 15 mm

Perforated chipboard

Reverse door leaf

Non-rebated / passive / sliding door leaf

Third hinge (rebated door)

Third hinge (non-rebated door)

Third hinge (reverse door)

Size 100'

RAL colours

LINEA PREMIUM LOFT

LACQUERED PANEL DOORS REBATED / NON-REBATED / REVERSE

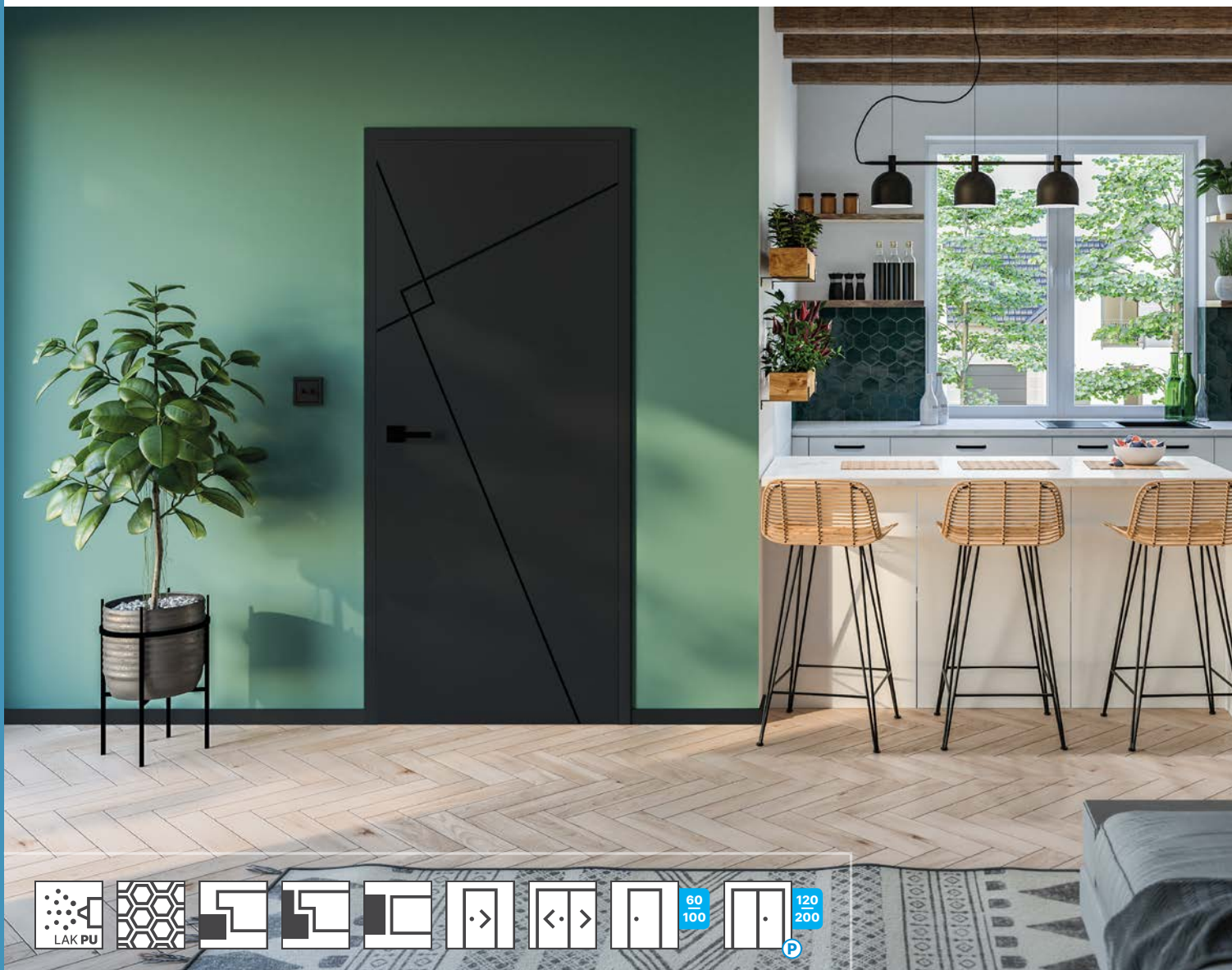

DOOR SPECIFICATION

- peripheral frame made of MDF board, reinforced with plywood, stabilizing "honeycomb" core

Rebated door leaf:

- two silver screw-in pintle hinges ¹
- lock: standard key lock / bathroom lock / cylinder lock / mortise lock ²

Non-rebated / reverse door leaf: ³

- two openings for 3D hidden hinges
- magnetic lock: standard key lock / bathroom lock / cylinder lock / mortise lock

RECOMMENDED DOOR FRAMES

Hard edge K:

- standard fixed and adjustable door frame, PU lacquered

Hard edge B:

- non-rebated adjustable or UV lacquered reverse door frame

¹ Door leaves 100' and reinforced door leaves regardless of the size - the set includes 3 hinges.

² For RAL 9005 Black, black locks.

³ For RAL 9005 Black, black locks. Black hinges only in the set with the door frame in 9005 Black lacquer.



model 1



model 2



model 3



model 4



model 5

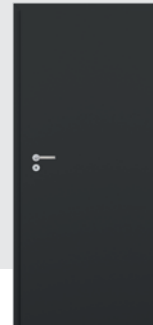

model 10
(smooth)



model 11

DETAILS



round groove
profile, width:
8 mm

PU lacquer



9005 BLACK

EXTRA-COST OPTIONS:

Ventilation undercut / recuperation 15 mm

Perforated chipboard

Reverse door leaf

Non-rebated / passive / sliding door leaf

Third hinge (rebated door)

Third hinge (non-rebated door)

Third hinge (reverse door)

Size 100'

RAL colours

MORANO

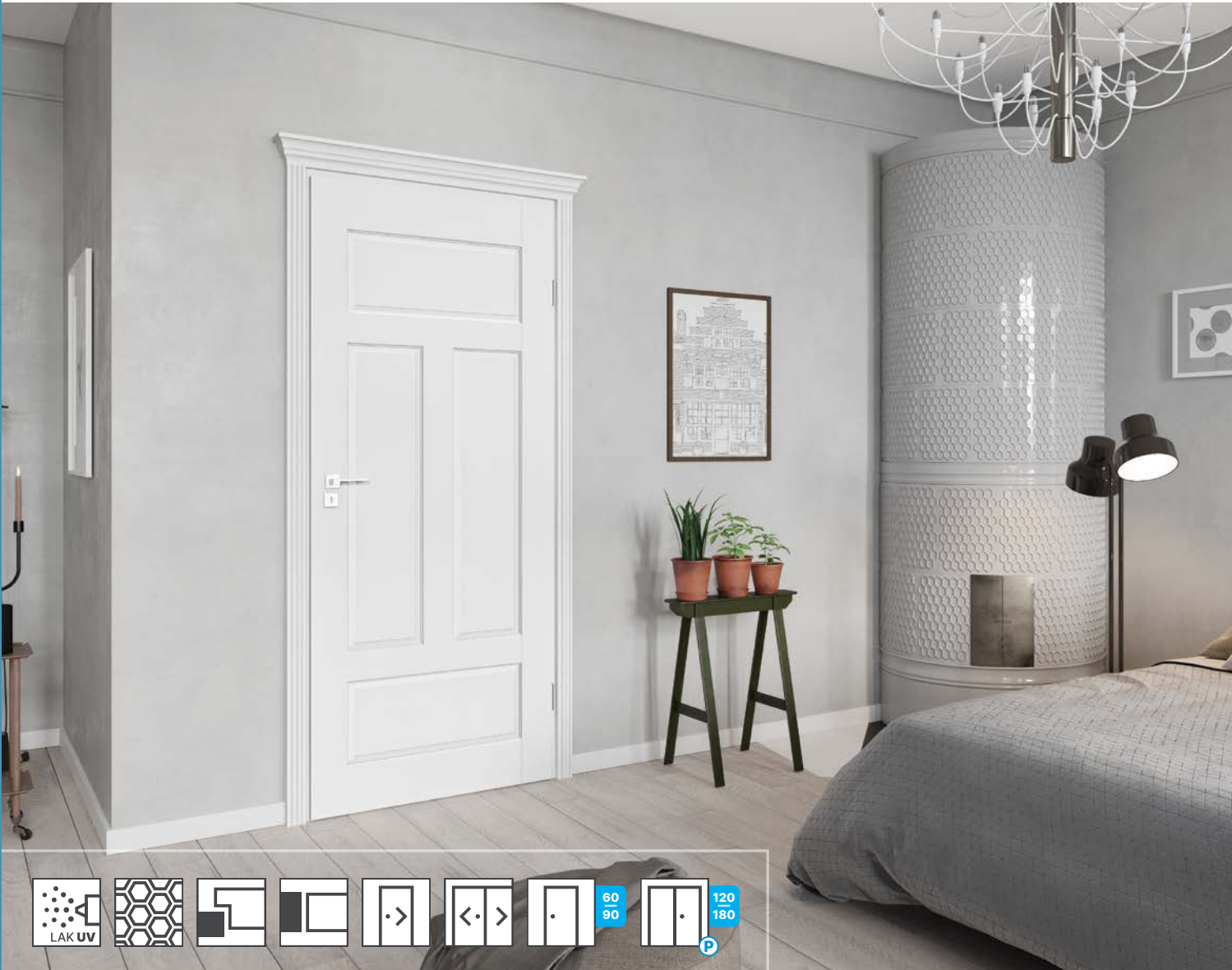

DOOR SPECIFICATION

- peripheral frame made of MDF board, reinforced with plywood, stabilizing "honeycomb" core
- milky-white toughened safety glass
- veneered glazing frame except for models 2.7-2.10 (lacquered frame)

Rebated door leaf:

- two silver screw-in pintle hinges
- lock: standard key lock / bathroom lock / cylinder lock / mortise lock

Non-rebated door leaf:

- two openings for 3D hidden hinges
- magnetic lock: standard key lock / bathroom lock / cylinder lock / mortise lock

RECOMMENDED DOOR FRAMES

Hard edge K:

- standard fixed and adjustable door frame, UV lacquered

Hard edge B:

- adjustable, non-rebated door frame, UV lacquered

¹ | Minimum order quantity in the case of RAL colour finish - 3 sets (door leaf + door frame).



model 1.1 model 1.2 model 1.3 model 1.4 model 1.5 (with muntins) model 2.1 model 2.2 model 2.3



model 2.4 (with muntins) model 2.5 (with muntins) model 2.6 model 2.7 model 2.8 model 2.9 (with muntins) model 2.10 (with muntins)

DETAILS



glazing frame



safety tempered satin glass



OPTION / tempered transparent glass for models 1.4, 1.5, 2.3, 2.4, 2.5



groove profile

UV lacquer



9003 WHITE



AVAILABLE IN RAL PALETTE ¹

EXTRA-COST OPTIONS:

- _____
Ventilation undercut / recuperation 15 mm
- _____
Ventilation sleeves (white)
- _____
Non-rebated / passive / sliding door leaf
- _____
Third hinge (rebated door)
- _____
Third hinge (non-rebated door)
- _____
Transparent glass for the following models: 1.4, 1.5, 2.3, 2.4, 2.5
- _____
RAL colours

SALVANO

LACQUERED PANEL DOORS REBATED / NON-REBATED

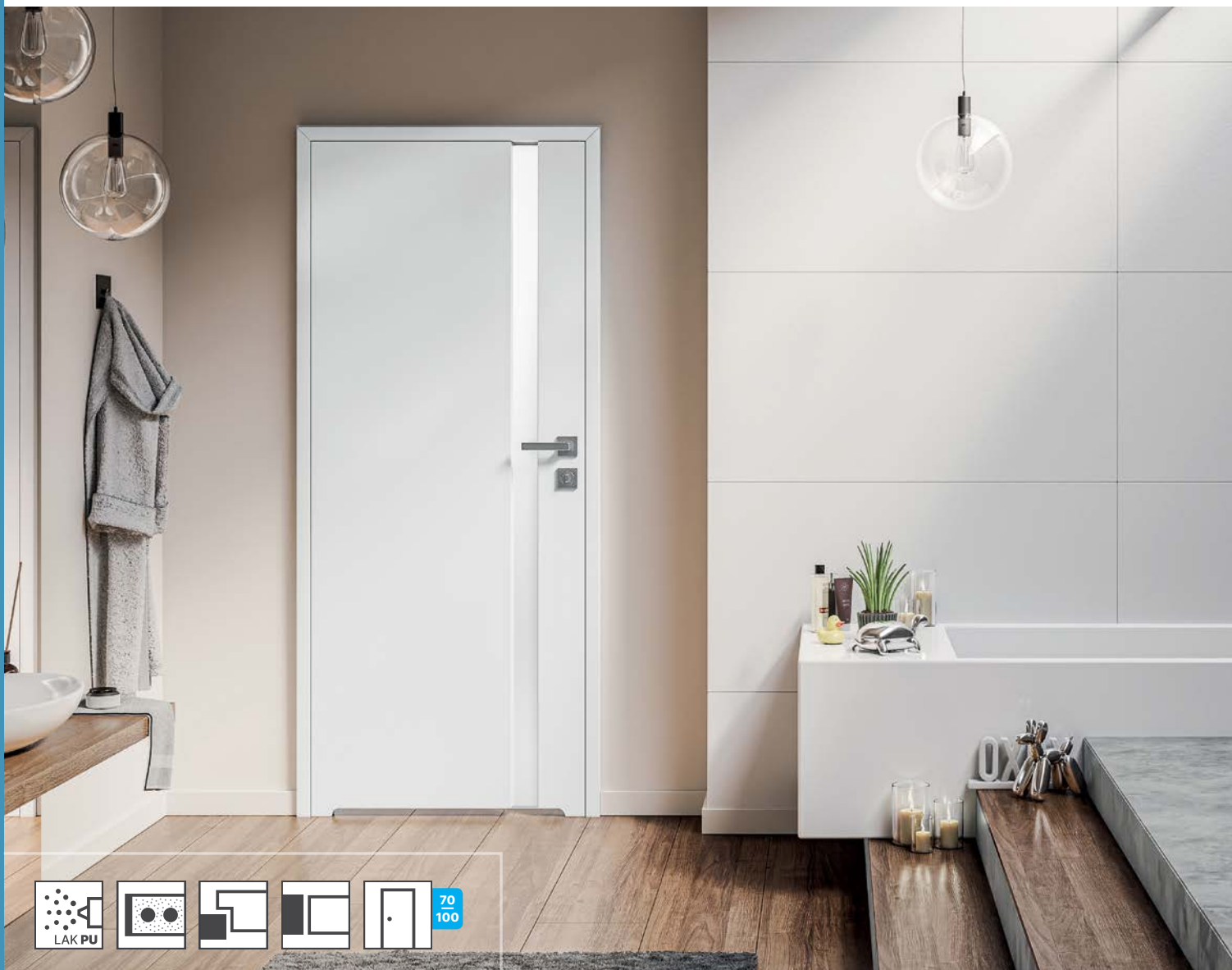

DOOR SPECIFICATION

- peripheral frame made of softwood, perforated chipboard core
- milky-white toughened safety glass

Rebated door leaf:

- three silver screw-in pintle hinges
- lock: standard key lock / bathroom lock / cylinder lock / mortise lock

Non-rebated door leaf:

- two openings for 3D hidden hinges
- magnetic lock: standard key lock / bathroom lock / cylinder lock / mortise lock

RECOMMENDED DOOR FRAMES

Hard edge K:

- standard fixed and adjustable door frame, UV lacquered

Hard edge B:

- non-rebated adjustable door frame, UV lacquered

¹ | Minimum order quantity in the case of RAL colour finish - 3 sets (door leaf + door frame).



model 1

model 2

model 3

model 4

model 5

DETAILS



milky-white
toughened safety
glass



OPTION / graphite
satin glass



ventilation undercut for all models

PU lacquer

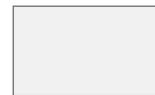

9003 WHITE



AVAILABLE IN RAL
PALETTE ¹

EXTRA-COST OPTIONS:

Ventilation undercut

Non-rebated door leaf

Third hinge (non-rebated door)

Graphite satin glass

Size 100'

RAL colours

CLASSIC

LACQUERED PANEL DOORS REBATED



DOOR SPECIFICATION

- peripheral frame made of MDF board, stabilizing honeycomb core
- ornamental glass, transparent bark

Rebated door leaf:

- two silver screw-in pintle hinges
- lock: standard key lock / bathroom lock / cylinder lock / mortise lock

RECOMMENDED DOOR FRAMES

Hard edge K:

- standard fixed and adjustable door frame, UV lacquered



full



1/3 glazed



2/3 glazed



3/3 glazed

DETAILS



ornamental glass,
transparent bark



glazing frame



door structure

UV lacquer



STRUCTURE
EFFECT WHITE



AVAILABLE IN RAL
PALETTE 2

EXTRA-COST OPTIONS:

Ventilation grille

Ventilation sleeves (white)

Passive door leaf

Third hinge (rebated door)



VENEER FRAME DOORS



veneer frame doors

Classics at its best. A great solution for those who instead of succumbing to seasonal fashions, choose timeless elegance. The framed construction provides the leaves with stability and increased resistance to damage. Inside the strong frame there are various types of fillings, including coffers, glazing, HDF panels and even mirrors. The variety of available models not only provides a real feast for the eye, but also a comfortable choice for future users. Choosing the door that best suits individual preferences and is precisely tailored to the needs of buyers.



DO YOU WANT TO WARM UP THE DECOR? Wood will be great for this. Not only on the floor, but also on the door leaves. Wood-like veneers with a three-dimensional structure will enhance the feeling of coziness.

INTERIOR CLOSE TO NATURE. Live plants, woven baskets and ecological decorations create a wonderful atmosphere. It will be complemented by wood-structured frame door, which you can easily adapt to the colour scheme of your flat.





DOOR SPECIFICATION

- frame elements made of MDF
- milky-white toughened safety glass
- 3D convex MDF coffers
- narrow MDF muntins (20 mm)

Rebated door leaf:

- three silver screw-in hinges
- lock: standard key lock / bathroom lock / cylinder lock / mortise lock ¹

Non-rebated door leaf: ²

- two openings for 3D hidden hinges
- magnetic lock: standard key lock / bathroom lock / cylinder lock / mortise lock

RECOMMENDED DOOR FRAMES

Hard edge K:

- fixed and adjustable door frames for rebated doors

Hard edge B:

- adjustable non-rebated door frame

¹ | For UNI Black decor black locks.

² | For UNI Black decor black locks. Black hinges only in the set with the door frame in UNI Black decor.



model 1.1



model 1.2



model 1.3



model 1.4



model 1.14



model 1.15

DETAILS



milky-white
toughened safety
glass

IRIDIUM



UNI WHITE

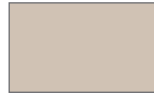

UNI CASHMERE



UNI GREEN



UNI GRAPHITE



UNI BLACK

IRIDIUM



GRANDSON OAK



MARRONE OAK

EXTRA-COST OPTIONS:

Ventilation undercut / recuperation 15 mm

Non-rebated / passive / sliding door leaf

Third hinge (non-rebated door)

Size 100'

MALIKA

NEW!

VENEER FRAME DOORS REBATED / NON-REBATED

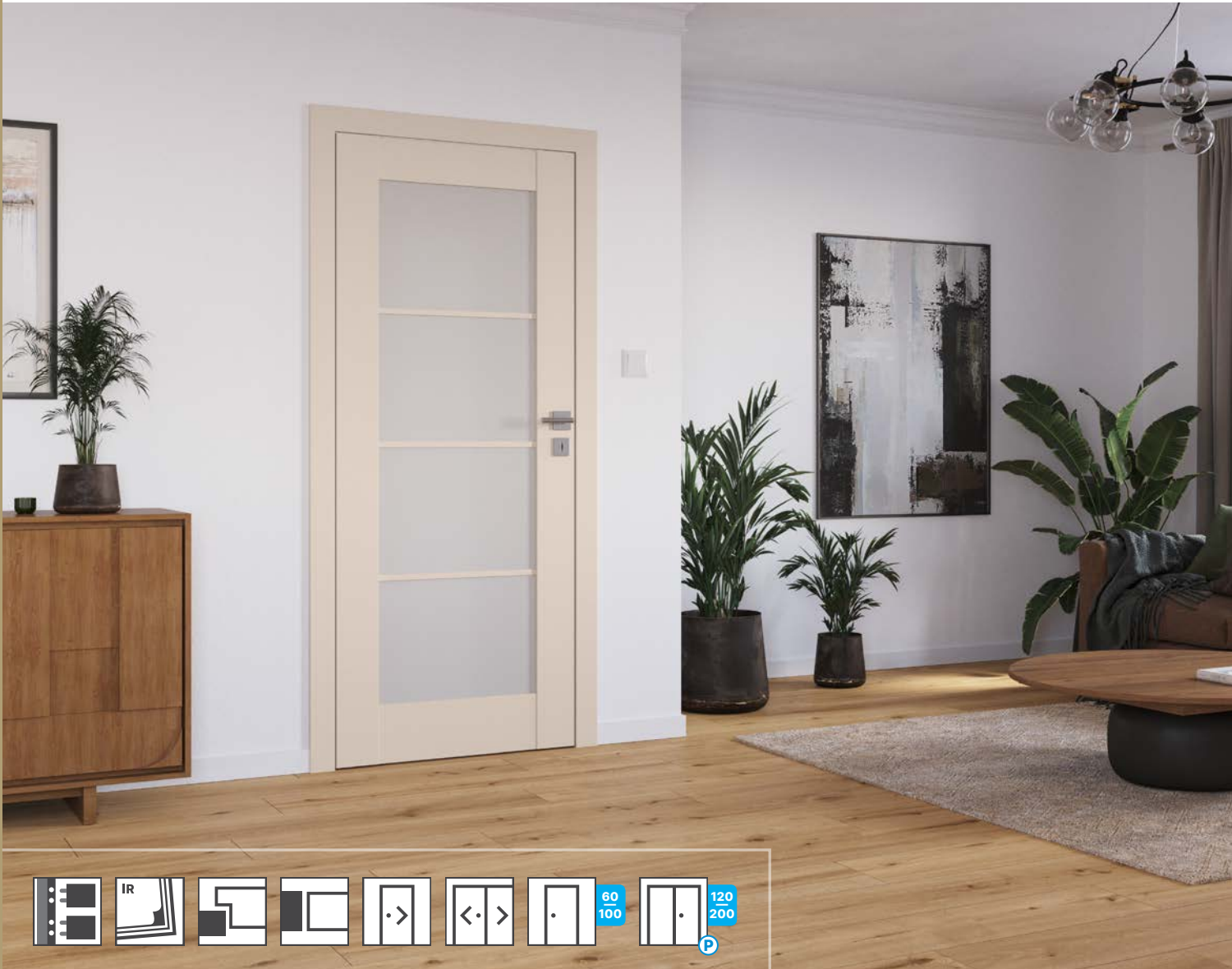

DOOR SPECIFICATION

- frame elements made of MDF
- milky-white toughened safety glass
- narrow MDF muntins (20 mm)

Rebated door leaf:

- three silver screw-in hinges
- lock: standard key lock / bathroom lock / cylinder lock / mortise lock ¹

Non-rebated door leaf: ²

- two openings for 3D hidden hinges
- magnetic lock: standard key lock / bathroom lock / cylinder lock / mortise lock

RECOMMENDED DOOR FRAMES

Hard edge K:

- fixed and adjustable door frames for rebated doors

Hard edge B:

- adjustable non-rebated door frame

¹ | For UNI Black decor black locks.

² | For UNI Black decor black locks. Black hinges only in the set with the door frame in UNI Black decor.

³ | For UNI Black decor, models 6 and 7 are the same, all muntins black.



model 1

model 2

model 3

model 4



model 5

model 6

model 7 ³

DETAILS



milky-white
toughened safety
glass

IRIDIUM



UNI WHITE



UNI CASHMERE



UNI GREEN



UNI GRAPHITE



UNI BLACK

IRIDIUM



GRANDSON OAK



MARRONE OAK

EXTRA-COST OPTIONS:

Ventilation undercut / recuperation 15 mm

Non-rebated / passive / sliding door leaf

Third hinge (non-rebated door)

Size 100'

MAMBA

NEW!

VENEER FRAME DOORS REBATED / NON-REBATED

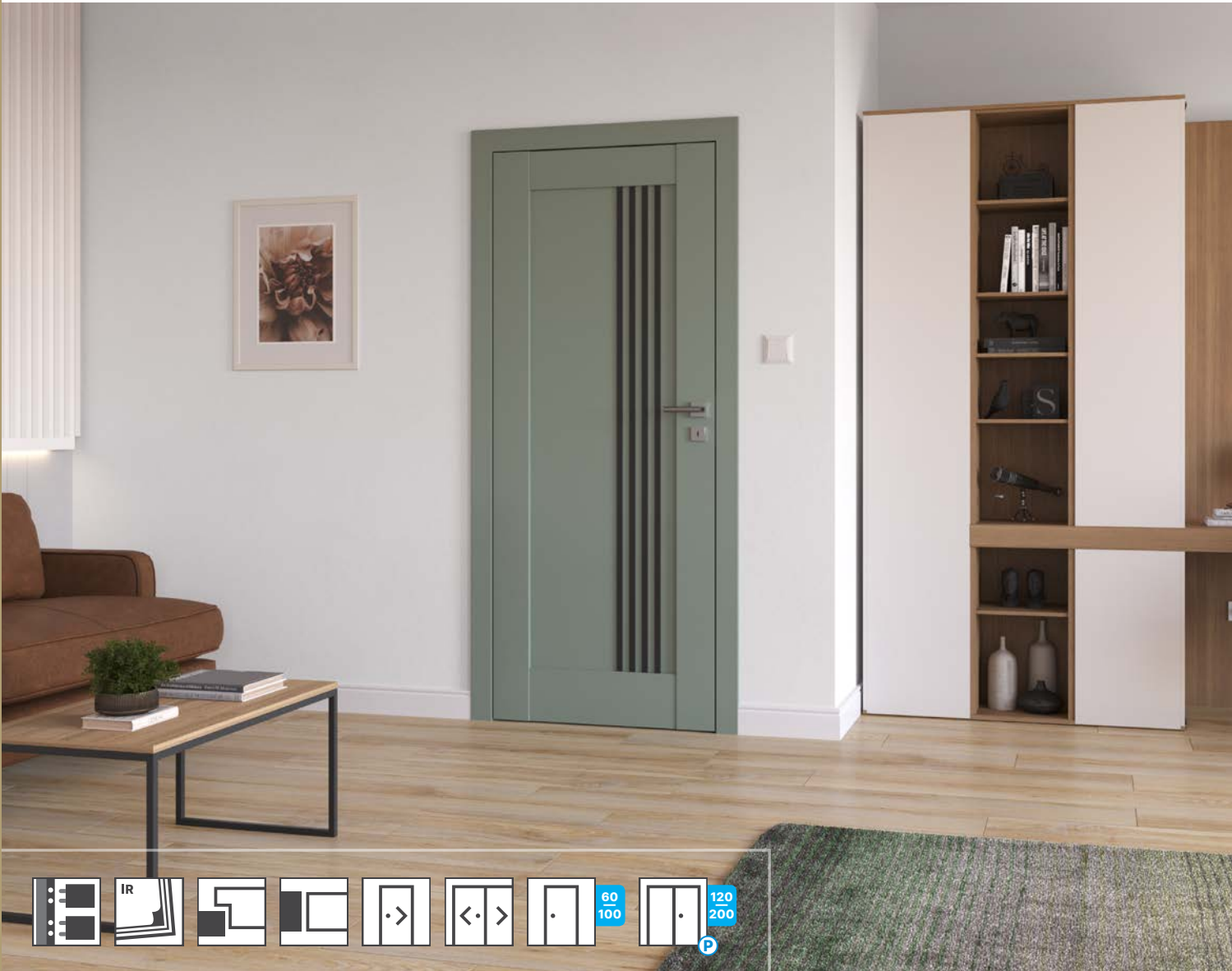

DOOR SPECIFICATION

- frame elements made of MDF
- smooth MDF coffer (8 mm)
- narrow black MDF muntins (20 mm)

Rebated door leaf:

- three silver screw-in hinges
- lock: standard key lock / bathroom lock / cylinder lock / mortise lock

Non-rebated door leaf:

- two openings for 3D hidden hinges
- magnetic lock: standard key lock / bathroom lock / cylinder lock / mortise lock

RECOMMENDED DOOR FRAMES

Hard edge K:

- fixed and adjustable door frames for rebated doors

Hard edge B:

- adjustable non-rebated door frame



model 1

model 2

model 3

model 4



model 5

model 6

model 7

DETAILS



smooth coffer with black muntins

IRIDIUM



UNI WHITE

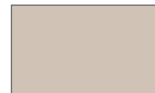

UNI CASHMERE



UNI GREEN



UNI GRAPHITE

IRIDIUM



GRANDSON OAK



MARRONE OAK

EXTRA-COST OPTIONS:

Ventilation undercut / recuperation 15 mm

Non-rebated / passive / sliding door leaf

Third hinge (non-rebated door)

Size 100'

FORMA NEW!

VENEER FRAME DOORS NON-REBATED

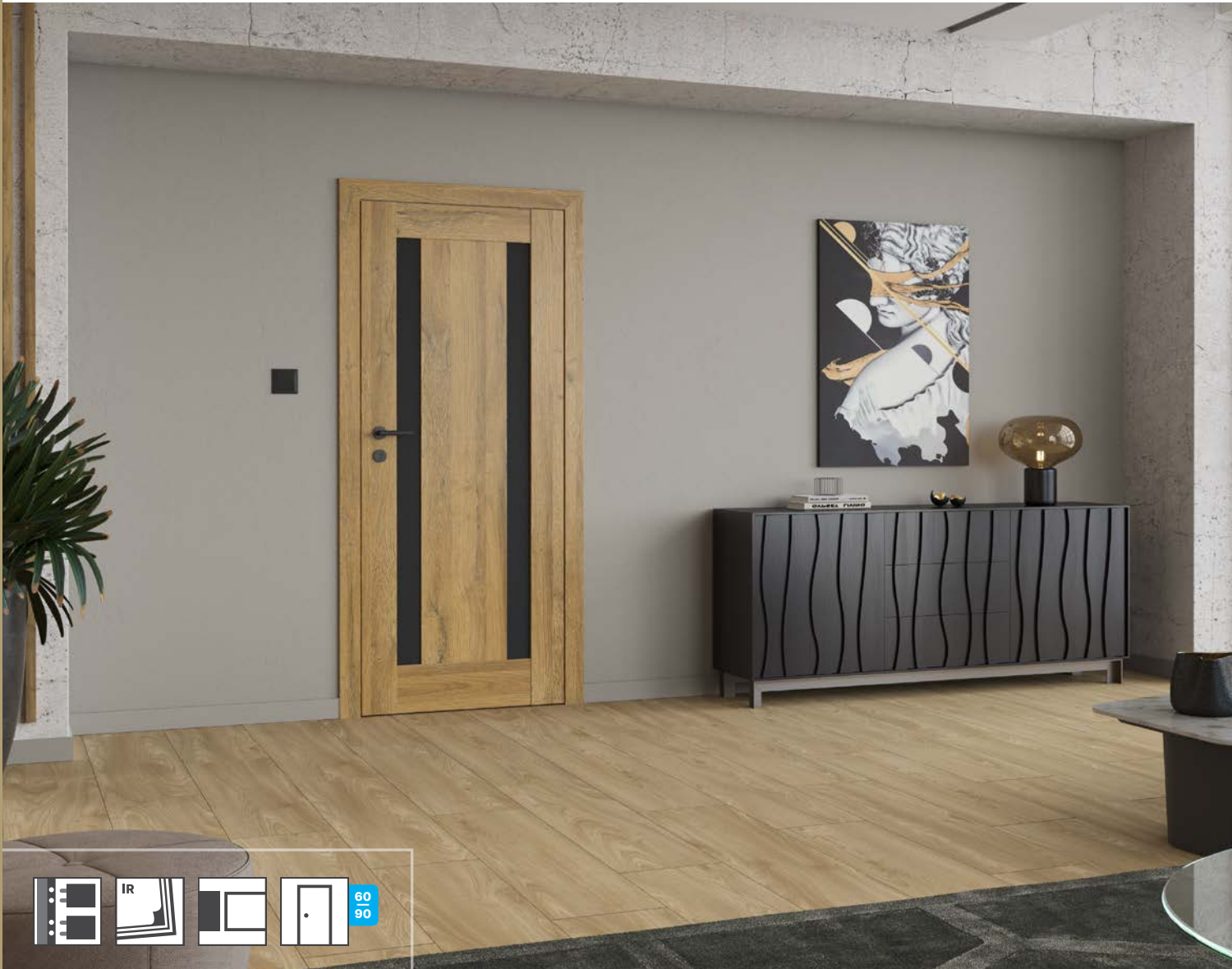

DOOR SPECIFICATION

- frame elements made of MDF
- models 1-3 UNI Black door panel, thickness: 4 mm
- models 4-6 milky-white toughened safety glass
- middle elements of the door leaf filling: "honeycomb" and MDF 18 mm

Non-rebated door leaf:

- two openings for 3D hidden hinges
- magnetic lock: standard key lock / bathroom lock / cylinder lock / mortise lock

RECOMMENDED DOOR FRAMES

Hard edge B:

- adjustable non-rebated door frame



model 1



model 2

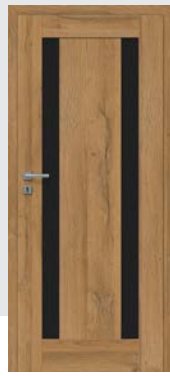

model 3



model 4



model 5

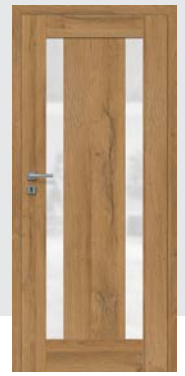

model 6

DETAILS



milky-white
toughened safety
glass



OPTION / graphite
satin glass

IRIDIUM



UNI WHITE



UNI CASHMERE



UNI GREEN



UNI GRAPHITE

IRIDIUM



GRANDSON OAK



MARRONE OAK

EXTRA-COST OPTIONS:

Ventilation undercut / recuperation 15 mm

Third hinge (non-rebated door)

Tempered, graphite satin glass



DOOR SPECIFICATION

- frame elements made of MDF
- satin glass or HDF panel in the door leaf colour, thickness 4 mm

Rebated door leaf:

- three silver screw-in hinges
- lock: standard key lock / bathroom lock / cylinder lock / mortise lock ¹

Non-rebated door leaf: ²

- available only in Iridium decors
- two openings for 3D hidden hinges
- magnetic lock: standard key lock / bathroom lock / cylinder lock / mortise lock

RECOMMENDED DOOR FRAMES

Hard edge K:

- fixed and adjustable door frames for rebated doors

Hard edge B:

- adjustable non-rebated door frame

¹ | For UNI Black decor black locks.

² | For UNI Black decor black locks. Black hinges only in the set with the door frame in UNI Black decor.

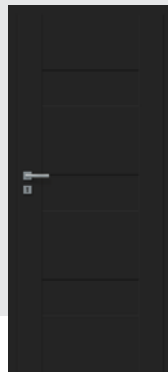

model 1

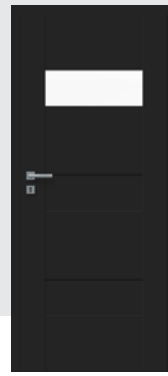

model 2



model 3

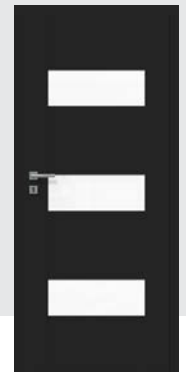

model 4

DETAILS



satin glass



OPTION / safety corrugated glass, vision

PRIMO



GREY MATT

3D LOOK



HONEY CATANIA



GESSATO OAK



CLEVELAND OAK



RIVIERA OAK



TOCANTIS OAK

3D LOOK



WHITE ASH



GREY OAK

IRIDIUM



UNI WHITE



UNI CASHMERE



UNI GREEN



UNI GRAPHITE

IRIDIUM



UNI BLACK



GRANDSON OAK



MARRONE OAK

EXTRA-COST OPTIONS:

Ventilation undercut / recuperation 15 mm

Non-rebated / passive / sliding door leaf

Third hinge (non-rebated door)

Vision ornamental glass

Size 100'

TUMULA NEW!

VENEER FRAME DOORS REBATED / NON-REBATED

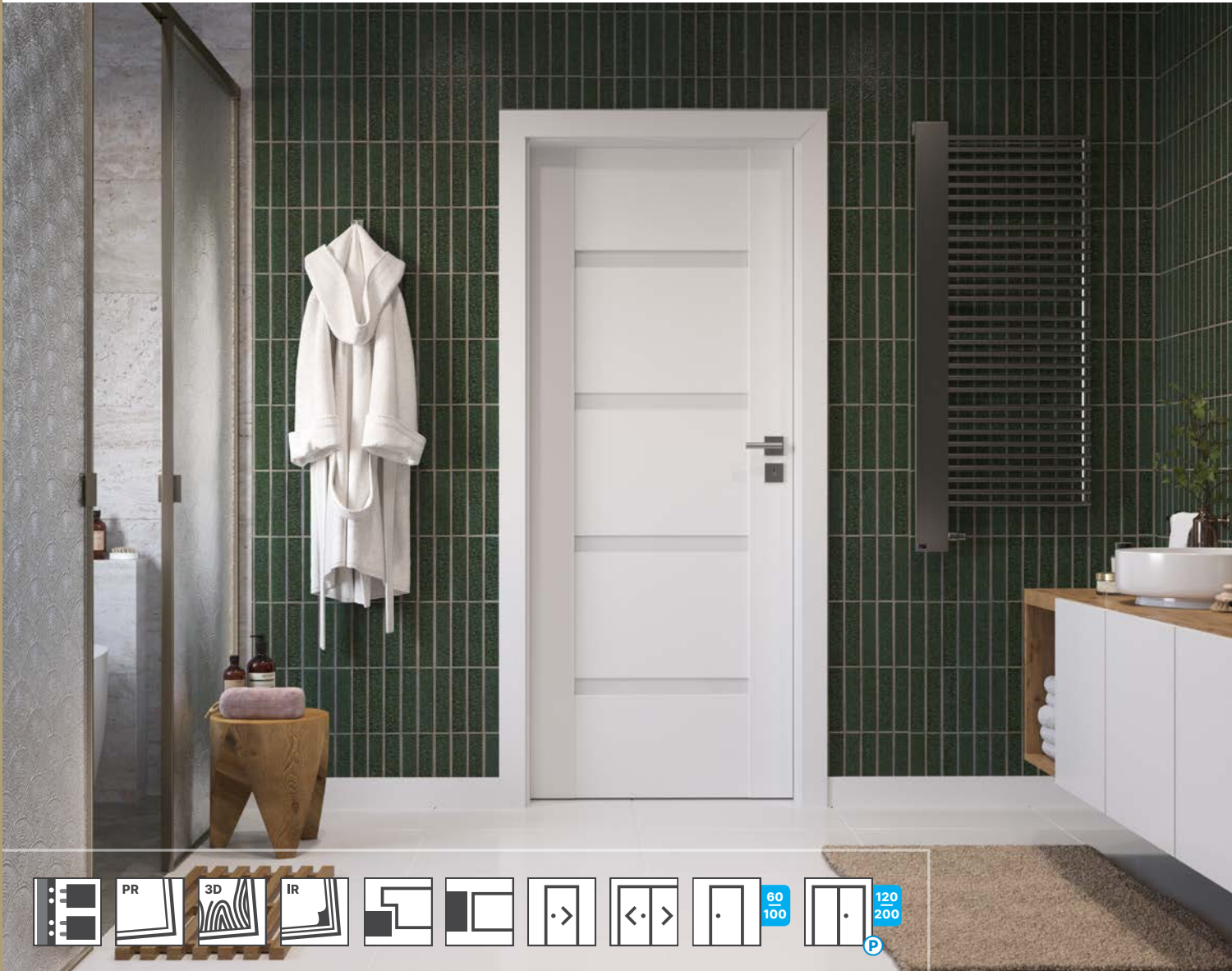

DOOR SPECIFICATION

- frame elements made of MDF
- satin glass or HDF panel in the door leaf colour, thickness 4 mm

Rebated door leaf:

- three silver screw-in hinges
- lock: standard key lock / bathroom lock / cylinder lock / mortise lock ¹

Non-rebated door leaf: ²

- available only in Iridium decors
- two openings for 3D hidden hinges
- magnetic lock: standard key lock / bathroom lock / cylinder lock / mortise lock

RECOMMENDED DOOR FRAMES

Hard edge K:

- fixed and adjustable door frames for rebated doors

Hard edge B:

- adjustable non-rebated door frame

¹ | For UNI Black decor black locks.

² | For UNI Black decor black locks. Black hinges only in the set with the door frame in UNI Black decor.



model 1

model 2

model 3

model 4

model 5

DETAILS



satin glass



OPTION / black glass

PRIMO



GREY MATT

3D LOOK



HONEY CATANIA



GESSATO OAK



CLEVELAND OAK



RIVIERA OAK



TOCANTIS OAK

3D LOOK



WHITE ASH



GREY OAK

IRIDIUM



UNI WHITE



UNI CASHMERE



UNI GREEN



UNI GRAPHITE

IRIDIUM



UNI BLACK



GRANDSON OAK



MARRONE OAK

EXTRA-COST OPTIONS:

Ventilation undercut / recuperation 15 mm

Non-rebated / passive / sliding door leaf

Third hinge (non-rebated door)

Black glass

Size 100'

CLIF

VENEER FRAME DOORS REBATED / NON-REBATED

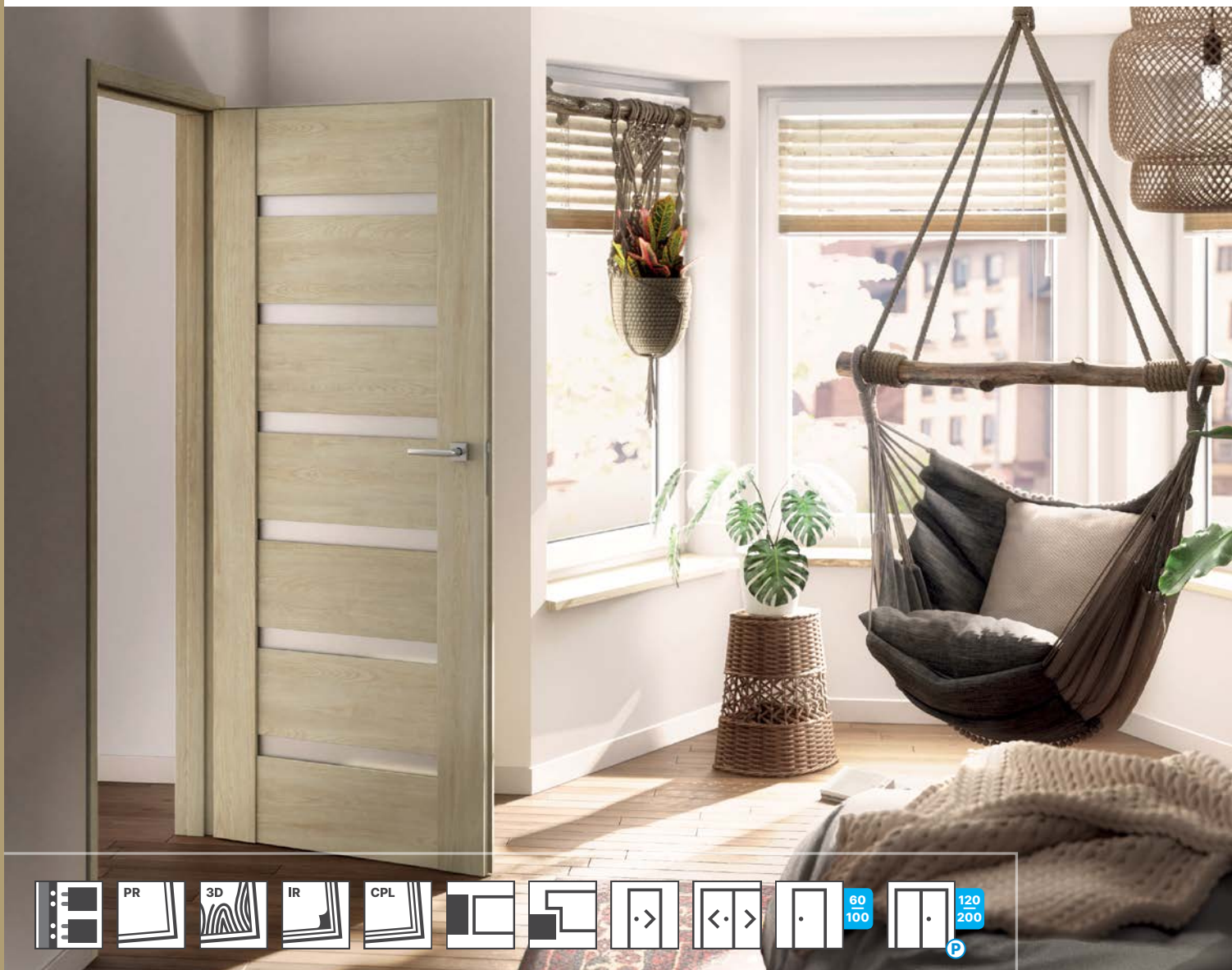

DOOR SPECIFICATION

- frame elements made of MDF
- satin glass or HDF panel in the door leaf colour, thickness 4 mm

Rebated door leaf:

- three silver screw-in hinges
- lock: standard key lock / bathroom lock / cylinder lock / mortise lock ¹

Non-rebated door leaf: ²

- available only in Iridium and CPL decors
- two openings for 3D hidden hinges
- magnetic lock: standard key lock / bathroom lock / cylinder lock / mortise lock

RECOMMENDED DOOR FRAMES

Hard edge K:

- fixed and adjustable door frames for rebated doors

Hard edge B:

- adjustable non-rebated door frame

¹ | For UNI Black decor black locks.

² | For UNI Black decor black locks. Black hinges only in the set with the door frame in UNI Black decor.



model 1

model 2

model 3

model 4

model 5

model 6

DETAILS



satin glass

PRIMO



GREY MATT

3D LOOK



HONEY CATANIA



GESSATO OAK



CLEVELAND OAK



COLOMBIA LIGHT WALNUT



TOCANTIS OAK

IRIDIUM



UNI WHITE



UNI CASHMERE



UNI GREEN



UNI GRAPHITE



UNI BLACK



GRANDSON OAK

IRIDIUM



MARRONE OAK

CPL



NORWEGIAN ASH

EXTRA-COST OPTIONS:

Ventilation undercut / recuperation 15 mm

Non-rebated / passive / sliding door leaf

Third hinge (non-rebated door)

Size 100'



model 1

model 2

model 3

model 4

model 5



model 6

model 7

model 8

DETAILS



satin glass

PRIMO



GREY MATT

3D LOOK



HONEY CATANIA



GESSATO OAK



CLEVELAND OAK



RIVIERA OAK



WHITE ASH



TOCANTIS OAK

3D LOOK



COLOMBIA LIGHT WALNUT



OILED OAK



GREY OAK

IRIDIUM



UNI WHITE



UNI CASHMERE



UNI GREEN

IRIDIUM



UNI GRAPHITE



UNI BLACK



GRANDSON OAK



MARRONE OAK



GRAPHITE ASH

CPL



NORWEGIAN ASH

EXTRA-COST OPTIONS:

Ventilation undercut / recuperation 15 mm

Non-rebated / passive / sliding door leaf

Third hinge (non-rebated door)

Size 100'

GRECO

VENEER FRAME DOORS REBATED / NON-REBATED



DOOR SPECIFICATION

- frame elements made of MDF
- satin glass or HDF panel in the door leaf colour, thickness 4 mm

Rebated door leaf:

- three silver screw-in hinges
- lock: standard key lock / bathroom lock / cylinder lock / mortise lock ¹

Non-rebated door leaf: ²

- available only in Iridium and CPL decors
- two openings for 3D hidden hinges
- magnetic lock: standard key lock / bathroom lock / cylinder lock / mortise lock

RECOMMENDED DOOR FRAMES

Hard edge K:

- fixed and adjustable door frames for rebated doors

Hard edge B:

- adjustable non-rebated door frame

¹ | For UNI Black decor black locks.

² | For UNI Black decor black locks. Black hinges only in the set with the door frame in UNI Black decor.



model 1

model 2

model 3

model 4

model 5

model 6



model 7

model 8

model 9

DETAILS



satin glass



OPTION / black glass

PRIMO



GREY MATT

3D LOOK



HONEY CATANIA



GESSATO OAK



CLEVELAND OAK



RIVIERA OAK



WHITE ASH



COLOMBIA LIGHT WALNUT

3D LOOK



OILED OAK



TOCANTIS OAK



GREY OAK

IRIDIUM



UNI WHITE



UNI CASHMERE



UNI GREEN



UNI GRAPHITE

IRIDIUM



UNI BLACK



GRANDSON OAK



GRAPHITE ASH



MARRONE OAK



NORWEGIAN ASH

CPL

EXTRA-COST OPTIONS:

Ventilation undercut / recuperation 15 mm

Non-rebated / passive / sliding door leaf

Third hinge (non-rebated door)

Black glass

Size 100'

HAVANA

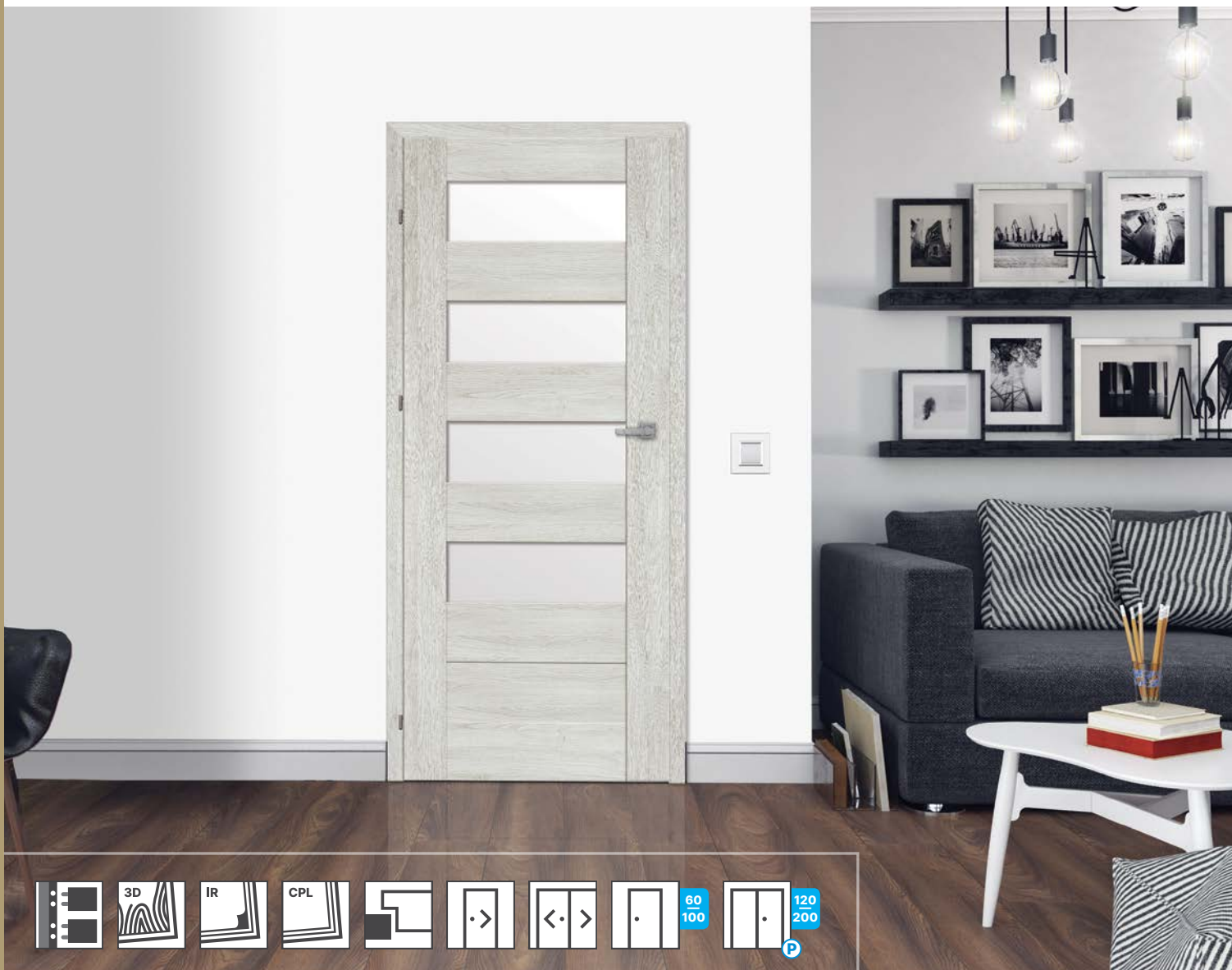

DOOR SPECIFICATION

- frame elements made of MDF
- satin glass or HDF panel in the door leaf
colour, thickness 4 mm

Rebated door leaf:

- three silver screw-in hinges
- lock: standard key lock / bathroom lock /
cylinder lock / mortise lock

RECOMMENDED DOOR FRAMES

Hard edge K:

- fixed and adjustable door frames for
rebated doors



model 1



model 2



model 3



model 4



model 5



model 6



model 7

DETAILS



satin glass

3D LOOK



RIVIERA OAK



WHITE ASH



COLOMBIA LIGHT WALNUT



OILED OAK



GREY OAK



SONOMA OAK

IRIDIUM



GRAPHITE ASH



UNI WHITE



NORWEGIAN ASH

EXTRA-COST OPTIONS:

Ventilation undercut / recuperation 15 mm

Passive / sliding door leaf

Size 100'

LUKKA

VENEER FRAME DOORS REBATED

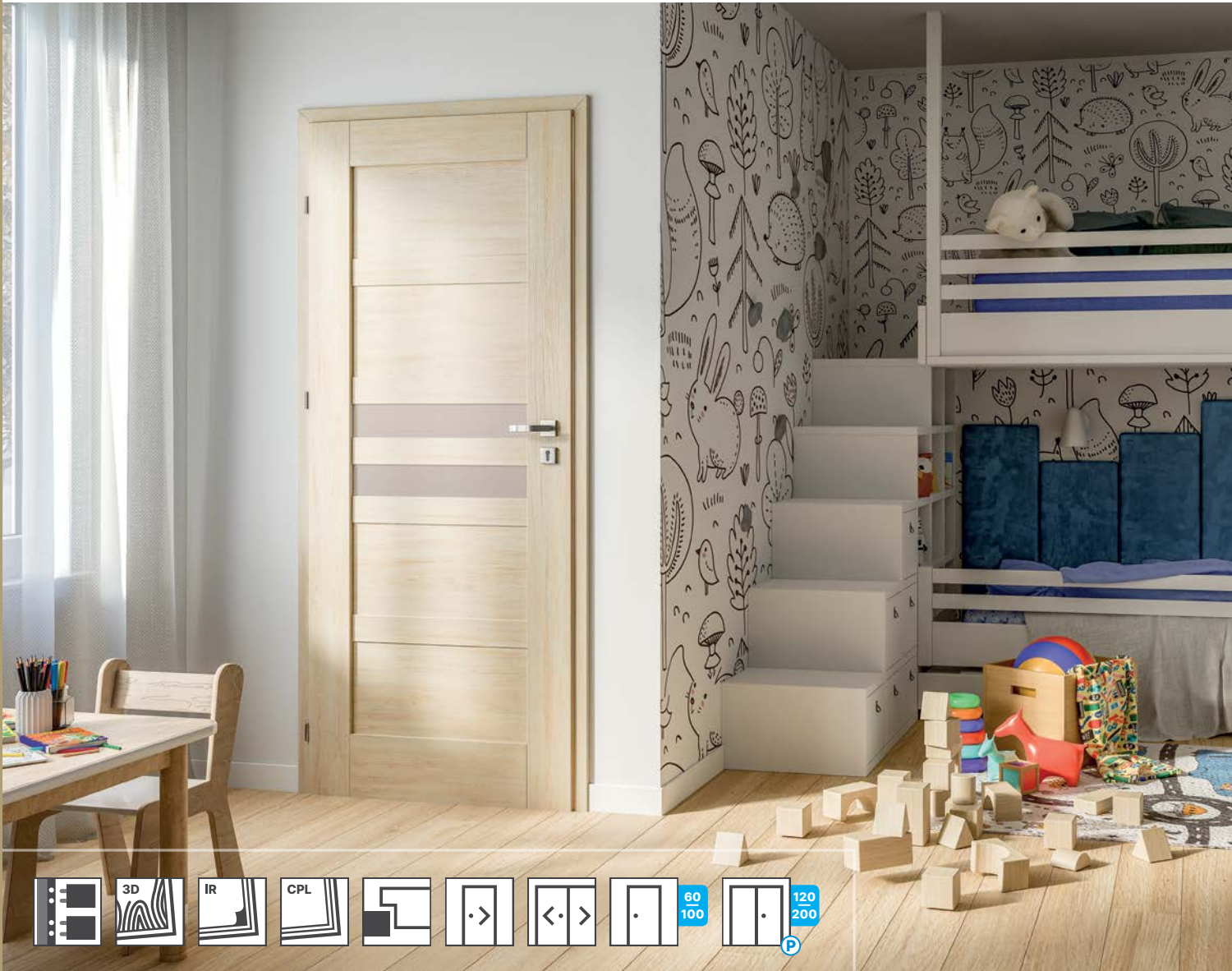

DOOR SPECIFICATION

- frame elements made of MDF
- satin glass or HDF panel in the door leaf colour, thickness 4 mm

Rebated door leaf:

- three silver screw-in hinges
- lock: standard key lock / bathroom lock / cylinder lock / mortise lock

RECOMMENDED DOOR FRAMES

Hard edge K:

- fixed and adjustable door frames for rebated doors



model 1

model 2

model 3

model 4

model 5

DETAILS



satin glass

3D LOOK

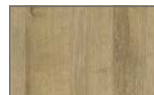

RIVIERA OAK



WHITE ASH



COLOMBIA LIGHT
WALNUT



OILED OAK

IRIDIUM



GRAPHITE ASH



UNI WHITE



MARRONE OAK



NORWEGIAN ASH

CPL

EXTRA-COST OPTIONS:

Ventilation undercut / recuperation 15 mm

Passive / sliding door leaf

Size 100'

TOSCA

VENEER FRAME DOORS REBATED



DOOR SPECIFICATION

- frame elements made of MDF
- satin glass or HDF panel in the door leaf
colour, thickness 4 mm

Rebated door leaf:

- three silver screw-in hinges
- lock: standard key lock / bathroom lock /
cylinder lock / mortise lock

RECOMMENDED DOOR FRAMES

Hard edge K:

- fixed and adjustable door frames for
rebated doors



model 1

model 2

model 3

model 4

model 5



model 6

model 7

model 8

DETAILS



satin glass

3D LOOK



RIVIERA OAK



WHITE ASH



COLOMBIA LIGHT
WALNUT



OILED OAK



GREY OAK



SONOMA OAK

IRIDIUM



GRAPHITE ASH



UNI WHITE



MARRONE OAK



NORWEGIAN ASH

CPL

EXTRA-COST OPTIONS:

Ventilation undercut / recuperation 15 mm

Passive / sliding door leaf

Size 100'

KOFANO

VENEER FRAME DOORS REBATED / NON-REBATED



DOOR SPECIFICATION

- frame elements made of MDF
- milky-white toughened safety glass or HDF panel in the door leaf colour, thickness 4 mm

Rebated door leaf:

- three silver screw-in hinges
- lock: standard key lock / bathroom lock / cylinder lock / mortise lock ¹

Non-rebated door leaf: ²

- available only in Iridium and CPL decors
- two openings for 3D hidden hinges
- magnetic lock: standard key lock / bathroom lock / cylinder lock / mortise lock

RECOMMENDED DOOR FRAMES

Hard edge K:

- fixed and adjustable door frames for rebated doors

Hard edge B:

- adjustable non-rebated door frame

¹ | For UNI Black decor black locks.

² | For UNI Black decor black locks. Black hinges only in the set with the door frame in UNI Black decor.



model 1.1 model 1.2 model 1.3 model 1.4 model 1.5 model 1.6 model 1.7 model 1.8



model 1.9 model 1.10 model 1.11 model 1.12 model 1.13

DETAILS



milky-white
toughened safety
glass



coffer profile

PRIMO



GREY MATT

3D LOOK



RIVIERA OAK



WHITE ASH



COLOMBIA LIGHT
WALNUT



OILED OAK

IRIDIUM



UNI WHITE

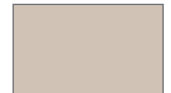

UNI CASHMERE

IRIDIUM



UNI GREEN



UNI GRAPHITE



UNI BLACK



GRANDSON OAK



GRAPHITE ASH



MARRONE OAK

CPL



NORWEGIAN ASH

EXTRA-COST OPTIONS:

Ventilation undercut / recuperation 15 mm

Non-rebated / passive / sliding door leaf

Third hinge (non-rebated door)

Size 100'



VENEER PANEL DOORS

veneer panel doors

Universal and thus guaranteeing versatile use. They are perfect for every room - from the kitchen and the living room to the bathroom. Thanks to them, it is possible to create a coherent design of the entire flat or house. The veneers covering the door leaves are durable and scratch resistant. Their advantage is also the variety of designs that fit into current trends and beautifully imitate the wood texture. You can find there not only classic beige and brown, but also shades of white, grey or anthracite. This rich palette of decors allows you to easily adapt them to any style of arrangement.



A SCANDINAVIAN INTERIOR WITH A TOUCH OF BOHO. An interesting combination for those who are looking for a way to break the simplicity of Scandinavian style. It is worth complementing the arrangement by using a door with white veneer, imitating wood texture.

CLASSIC DECOR DOESN'T HAVE TO BE BORING. Are you looking for timeless yet distinctive doors? Choose the door leaves with veneered surface. You can choose from many different colours. You will surely find the one that will create a coherent composition together with the other elements of the decor.



MODUL

VENEER PANEL REBATED / NON-REBATED / REVERSE



DOOR SPECIFICATION

- peripheral frame made of softwood
- inlay: 31 mm thick MDF insert in three widths: 40 mm, 80 mm, 154 mm

Rebated door leaf:

- three silver screw-in pintle hinges
- lock: standard key lock / bathroom lock / cylinder lock / mortise lock ¹

Non-rebated / reverse door leaf: ²

- two openings for 3D hidden hinges
- magnetic lock: standard key lock / bathroom lock / cylinder lock / mortise lock
- ABS edging as standard (does not apply to reverse door leaves)

DURABLE EDGING

RECOMMENDED DOOR FRAMES

Hard edge K:

- adjustable door frames for rebated doors
- fixed door frame for rebated doors (except Hamilton Oak and Hickory Oak decors)

Hard edge B / Rewers:

- adjustable non-rebated door frame
- adjustable reverse door frame (except Hamilton Oak and Hickory Oak decors)

¹ | For UNI Black decor black locks.

² | For UNI Black decor black locks. Black hinges only in the set with the door frame in UNI Black colour.

³ | Hamilton Oak and Hickory Oak decors available only with adjustable rebated and non-rebated door frame.



model 1b

model 2b

model 3b

model 1hi

model 2hi

model 3hi



model 1c

model 2c

model 3c

model 1h

model 2h

model 3h

DETAILS



veneer insert
hi - Hickory Oak

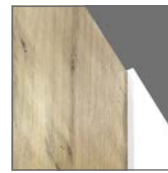

veneer insert
h - Hamilton Oak



veneer insert
b - UNI White



veneer insert
c - UNI Black

IRIDIUM



UNI WHITE



UNI BLACK

CPL³



HAMILTON OAK



HICKORY OAK

EXPLANATION OF MODEL DESCRIPTIONS:

- b – UNI White insert
- c – Uni Black insert
- h – Hamilton Oak insert
- hi – Hickory Oak insert

EXTRA-COST OPTIONS:

Ventilation undercut / recuperation 15 mm

Reverse door leaf

Non-rebated / passive / sliding door leaf

Third hinge (non-rebated door)

Third hinge (reverse door)

Size 100'

DARK

VENEER PANEL REBATED / NON-REBATED / REVERSE

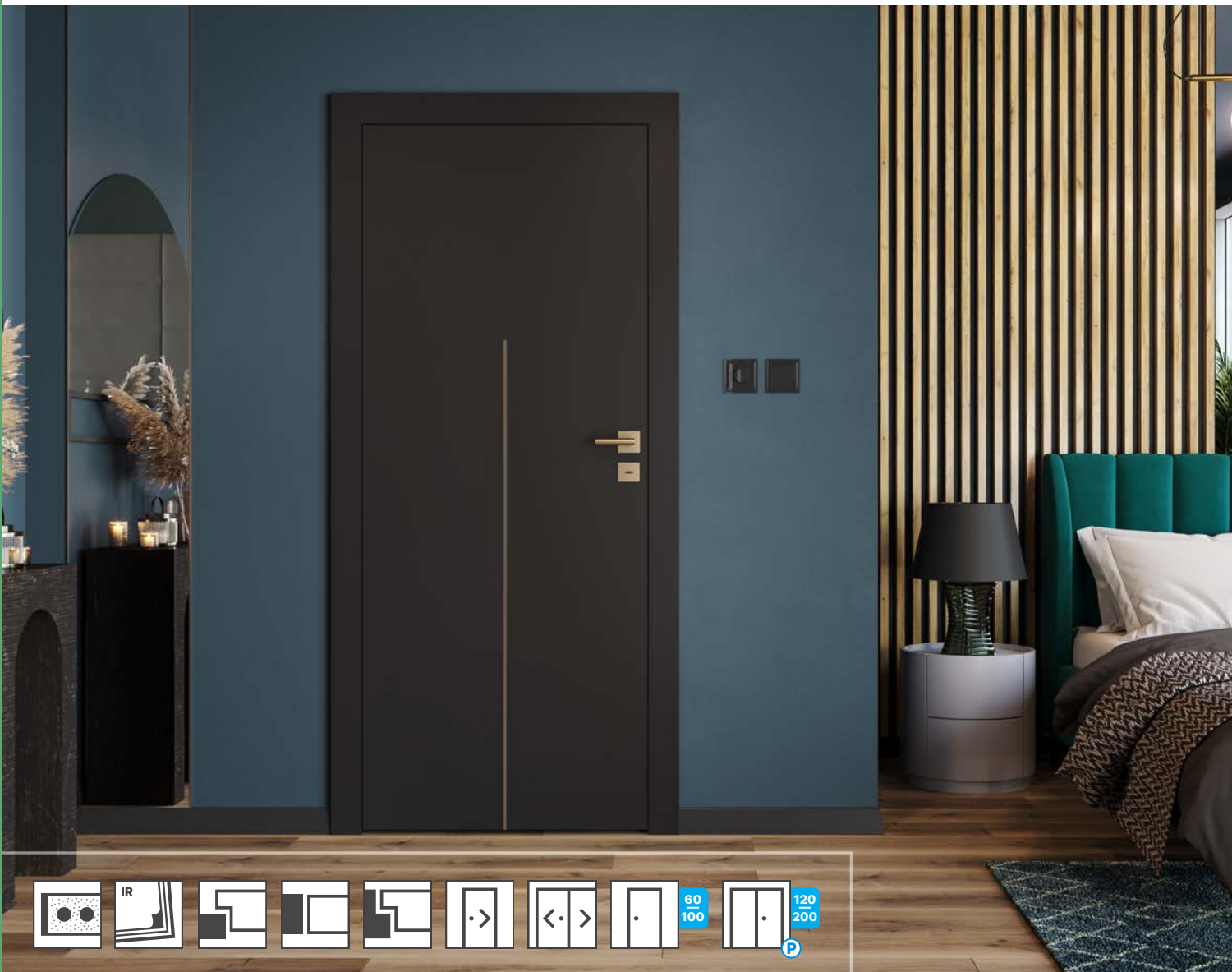

DOOR SPECIFICATION

- reinforced peripheral frame made of MDF
- inlay: gold aluminium profile, width: 8 mm, aligned with the door leaf surface

Rebated door leaf:

- three silver screw-in pintle hinges
- lock: standard key lock / bathroom lock / cylinder lock / mortise lock ¹

Non-rebated / reverse door leaf: ²

- two openings for 3D hidden hinges
- magnetic lock: standard key lock / bathroom lock / cylinder lock / mortise lock
- ABS edging as standard (does not apply to reverse door leaves)

DURABLE EDGING

RECOMMENDED DOOR FRAMES

Hard edge K:

- adjustable door frames for rebated doors
- fixed door frame for rebated doors

Hard edge B / Rewers:

- adjustable non-rebated door frame i reweryjna

¹ | For UNI Black decor black locks.

² | For UNI Black decor black locks. Black hinges only in the set with the door frame in UNI Black colour.

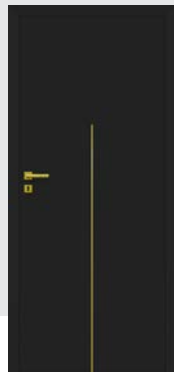

model 1



model 2



model 3

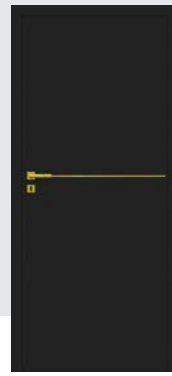

model 4

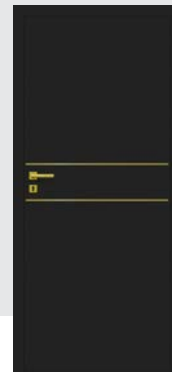

model 5

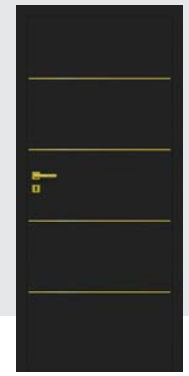

model 6

DETAILS



gold aluminium
profile, 8 mm

IRIDIUM

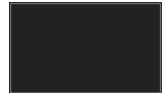

UNI BLACK

EXTRA-COST OPTIONS:

Ventilation undercut / recuperation 15 mm

Reverse door leaf

Non-rebated / passive / sliding door leaf

Third hinge (non-rebated door)

Third hinge (reverse door)

Size 100'

MILK

VENEER PANEL REBATED / NON-REBATED / REVERSE

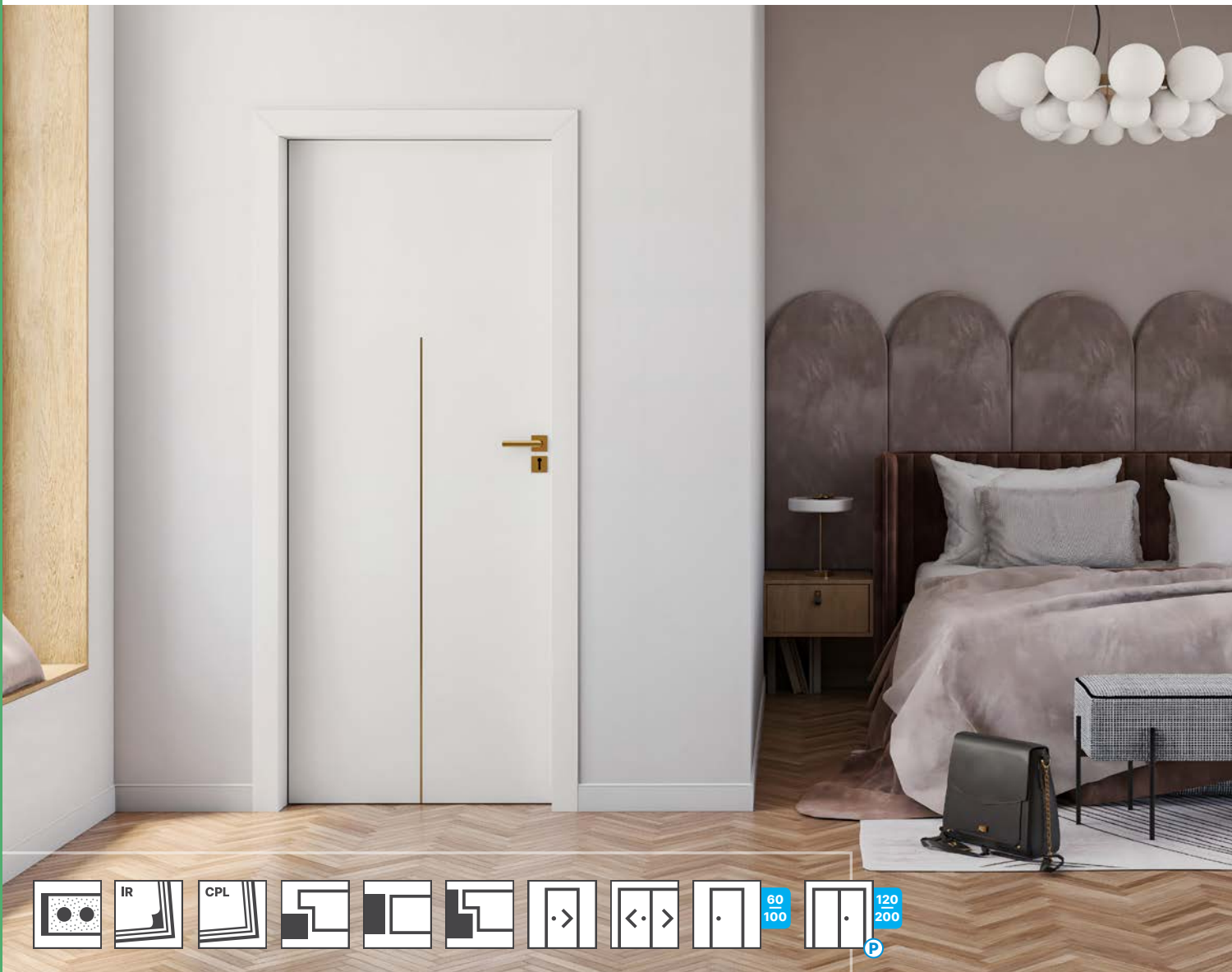

DOOR SPECIFICATION

- reinforced peripheral frame made of MDF
- inlay: alu, gold and black aluminium profile, width: 8 mm, aligned with the door leaf surface

Rebated door leaf:

- three silver screw-in pintle hinges
- lock: standard key lock / bathroom lock / cylinder lock / mortise lock

Non-rebated / reverse door leaf:

- two openings for 3D hidden hinges
- magnetic lock: standard key lock / bathroom lock / cylinder lock / mortise lock
- ABS edging as standard (does not apply to reverse door leaves)

DURABLE EDGING

RECOMMENDED DOOR FRAMES

Hard edge K:

- adjustable door frames for rebated doors
- fixed door frame for rebated doors (except CPL Cashmere decor)

Hard edge B / Rewers:

- adjustable non-rebated door frame
- adjustable reverse door frame (except Cashmere decor)

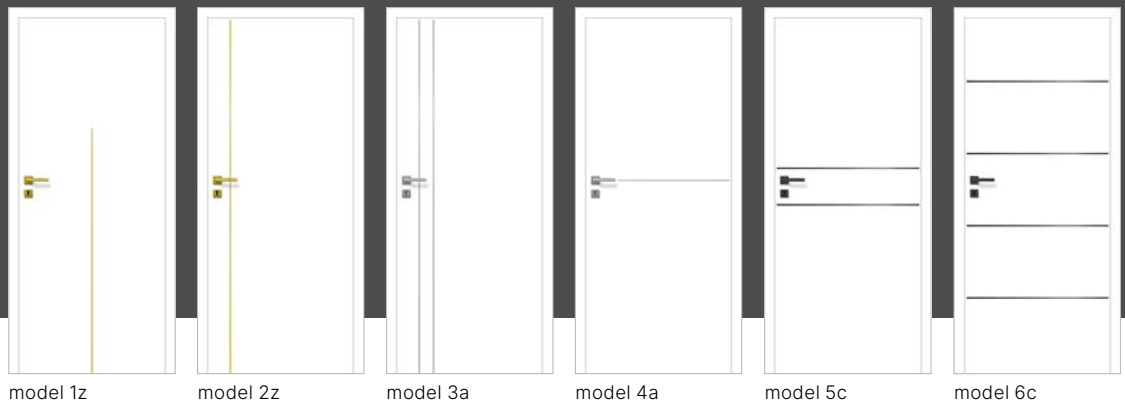

DETAILS



aluminium profile
a - alu 8 mm

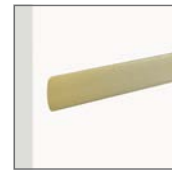

aluminium profile
z - gold 8 mm



aluminium profile
c - black 8 mm

IRIDIUM



UNI WHITE

CPL

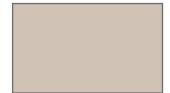

CASHMERE

EXPLANATION OF MODEL DESCRIPTIONS:

- a – aluminium profile
- z – gold aluminium profile
- c – black aluminium profile

EXTRA-COST OPTIONS:

Ventilation undercut / recuperation 15 mm

Reverse door leaf

Non-rebated / passive / sliding door leaf

Third hinge (non-rebated door)

Third hinge (reverse door)

Size 100'

VERTI

ENEER PANEL REBATED / NON-REBATED / REVERSE



DOOR SPECIFICATION

- reinforced peripheral frame made of MDF
- inlay: black aluminium profile, width: 8 mm, aligned with the door leaf surface
- models 1-3 available in decor with vertical graining
- models 4-6 available in decor with horizontal graining

Rebated door leaf:

- three silver screw-in pintle hinges
- lock: standard key lock / bathroom lock / cylinder lock / mortise lock

Non-rebated / reverse door leaf:

- two openings for 3D hidden hinges
- magnetic lock: standard key lock / bathroom lock / cylinder lock / mortise lock
- ABS edging as standard (does not apply to reverse door leaves)

DURABLE EDGING

RECOMMENDED DOOR FRAMES

Hard edge K:

- adjustable door frames for rebated doors

Hard edge B / Rewers:

- adjustable non-rebated door frame
- adjustable reverse door frame available in UNI Black decor

¹ For doors in Hamilton Oak horizontal decor there is special adjustable rebated and non-rebated door frame available in Hamilton Oak vertical decor.



model 1



model 2



model 3



model 4



model 5



model 6

DETAILS



aluminium profile
black 8 mm

CPL



HAMILTON OAK
VERTICAL



HAMILTON OAK
HORIZONTAL ³

EXTRA-COST OPTIONS:

Ventilation undercut / recuperation 15 mm

Reverse door leaf

Non-rebated / passive / sliding door leaf

Third hinge (non-rebated door)

Third hinge (reverse door)

Size 100'

GLAS

VENEER PANEL REBATED / NON-REBATED / REVERSE

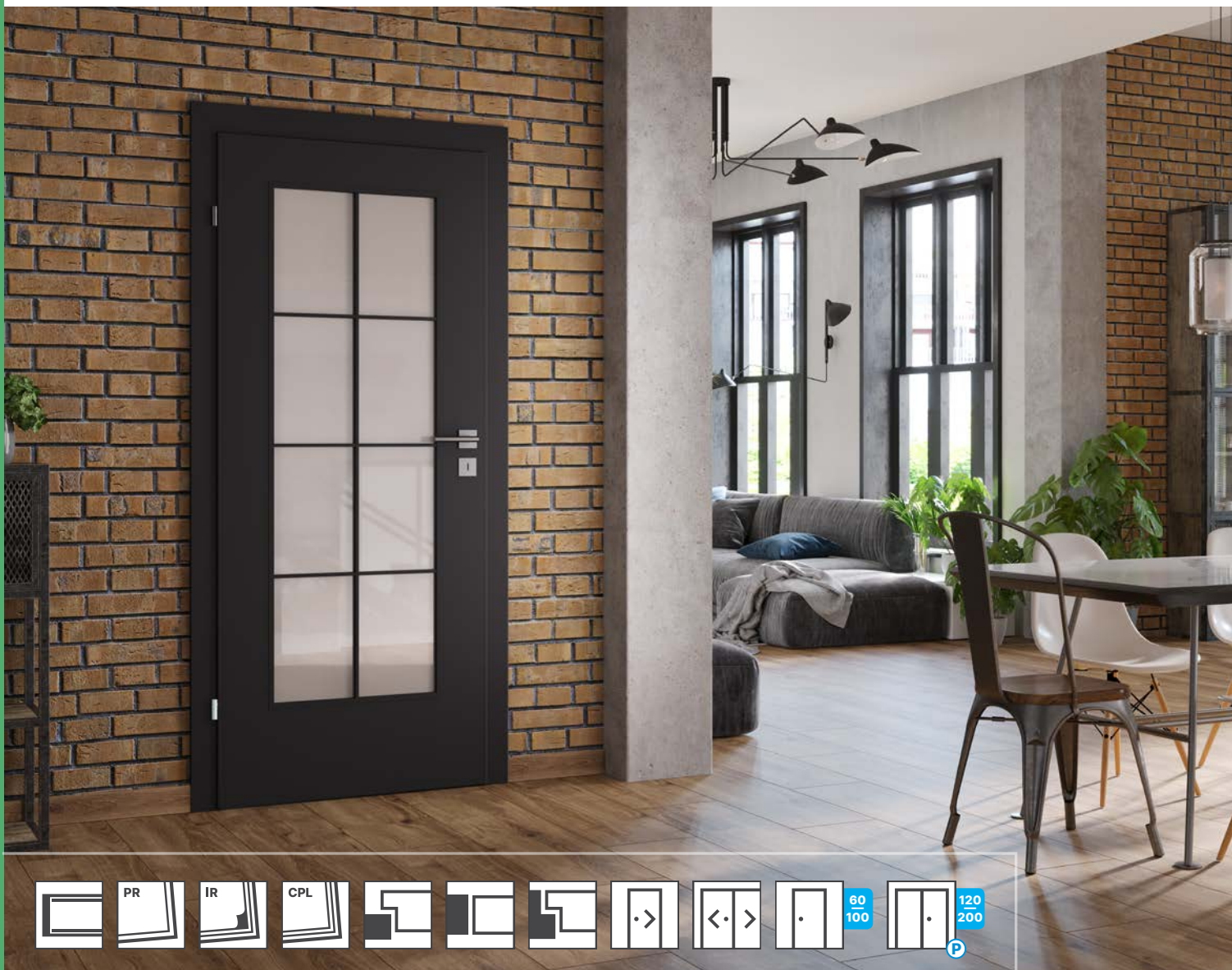

DOOR SPECIFICATION

- Classen Hard construction
- milky-white toughened safety glass

Rebated door leaf:

- two silver screw-in pintle hinges ¹
- lock: standard key lock / bathroom lock / cylinder lock / mortise lock ²

Non-rebated / reverse door leaf: ³

- two openings for 3D hidden hinges
- magnetic lock: standard key lock / bathroom lock / cylinder lock / mortise lock
- ABS edging as standard for UNI White, UNI Black, Hamilton Oak and Cashmere decors (does not apply to reverse door leaves)

DURABLE EDGING

RECOMMENDED DOOR FRAMES

Hard edge K:

- adjustable door frames for rebated doors
- fixed door frame for rebated doors (except Hamilton Oak and Cashmere decors)

Hard edge B / Rewers:

- adjustable non-rebated door frame
- adjustable reverse door frame (except Hamilton Oak and Cashmere decors)

¹ Door leaves 100' and reinforced door leaves regardless of the size - 3 hinges.

² For UNI Black decor black locks.

³ For UNI Black decor black locks. Black hinges only in the set with the door frame in UNI Black colour.

⁴ Hamilton Oak and Cashmere decors available only with adjustable rebated and non-rebated door frame.

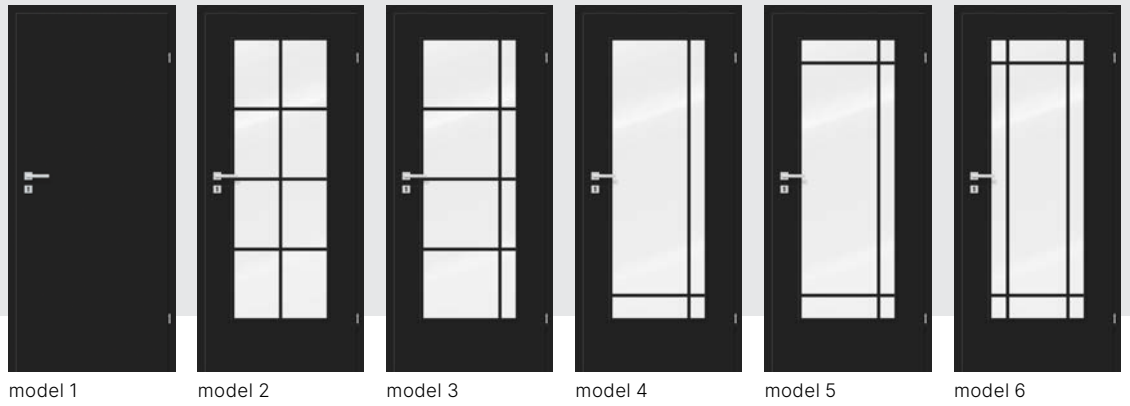

DETAILS



milky-white
toughened safety
glass

OPTION / transparent
tempered glass

glazing frame

PRIMO



GREY MATT

IRIDIUM



UNI WHITE

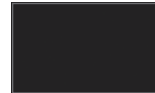

UNI BLACK



MARRONE OAK



GRANDSON OAK

CPL



LIGHT ACACIA



NORWEGIAN ASH



GRIGIO OAK



KENDAL OAK



HAMILTON OAK ⁴

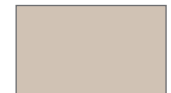

CASHMERE ⁴

EXTRA-COST OPTIONS:

Ventilation undercut / recuperation 15 mm

Perforated chipboard

Reverse door leaf

Non-rebated / passive / sliding door leaf

Third hinge (rebated door)

Third hinge (non-rebated door)

Third hinge (reverse door)

Size 100'

Transparent glass

DISCOVERY

VENEER PANEL REBATED / NON-REBATED / REVERSE

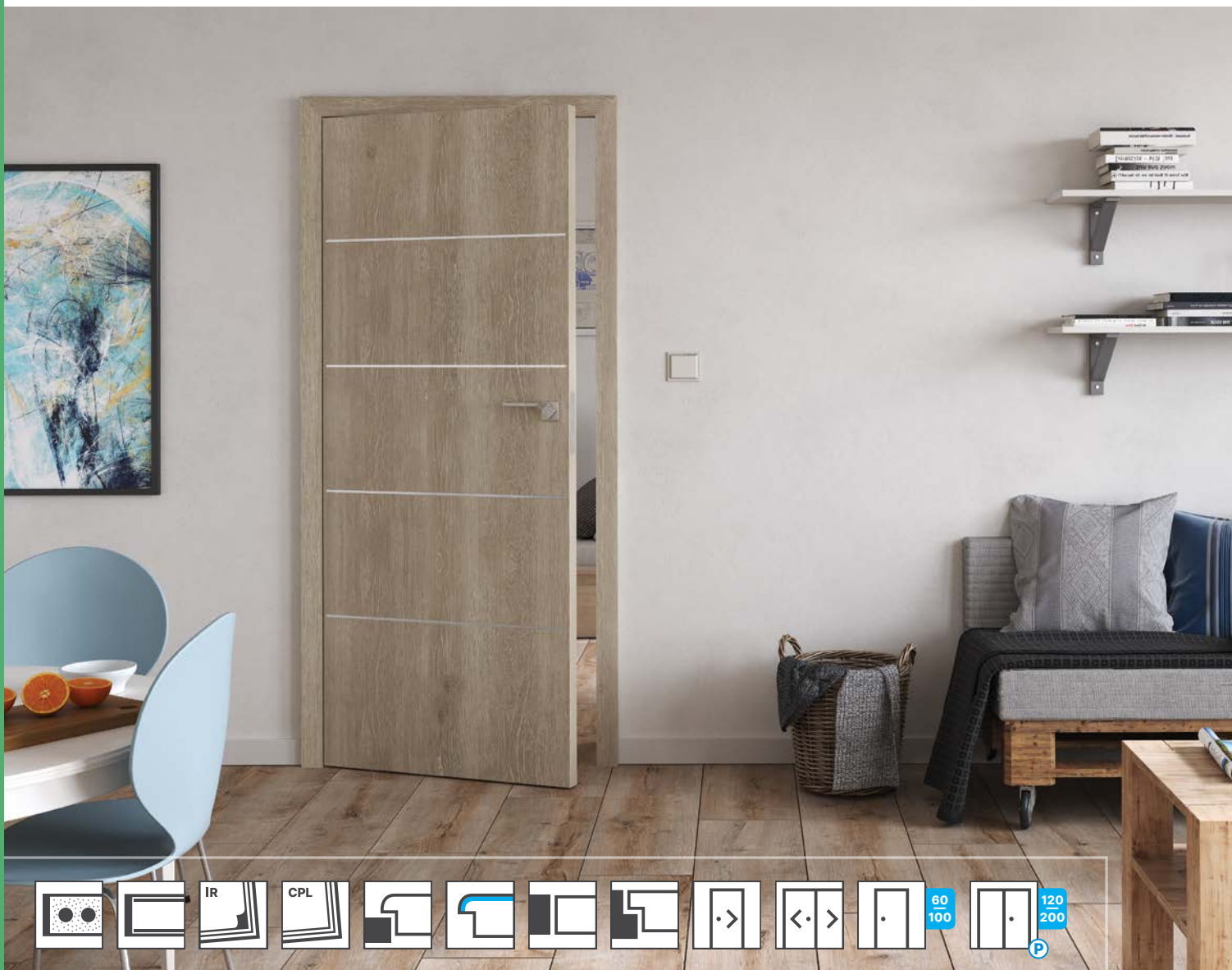

DOOR SPECIFICATION

- Hard Edge R door leaf edge profile for Iridium decors, peripheral frame made of softwood ¹
- Hard Edge PF door leaf edge profile for CPL decors, peripheral frame made of MDF board, reinforced ¹
- inlay: aluminium profile, width: 8 mm, aligned with the door leaf surface
- milky-white toughened safety glass with a transparent inlay

Rebated door leaf:

- three silver screw-in pintle hinges
- lock: standard key lock / bathroom lock / cylinder lock / mortise lock

Non-rebated / reverse door leaf:

- two openings for 3D hidden hinges
- magnetic lock: standard key lock / bathroom lock / cylinder lock / mortise lock

RECOMMENDED DOOR FRAMES

Hard edge PF/R:

- adjustable door frames for rebated doors
- fixed door frame for rebated doors (except Hamilton Oak, Hickory Oak, and Cashmere decors)

Hard edge B / Rewers:

- adjustable non-rebated door frame
- adjustable reverse door frame (except Hamilton Oak, Hickory Oak and Cashmere decors)

¹ | Perforated chipboard core (models 4-11), Classen Hard construction (models 1-3).

² | Hard Edge PF door construction for CPL decors.

³ | For doors in Hamilton Oak horizontal decor there is special door frame available finished in Hamilton Oak vertical decor.



model 1 model 2 model 3 model 4 model 5



model 6 model 10 model 11

DETAILS



milky-white toughened safety glass with a transparent overprint

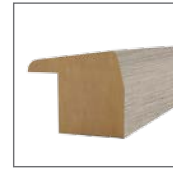

glazing frame



aluminium profile 8mm

IRIDIUM



GRAPHITE ASH



MARRONE OAK



GRANDSON OAK



LIGHT ACACIA



NORWEGIAN ASH



ITALIAN WALNUT



GRIGIO OAK

CPL²



HAMILTON OAK HORIZONTAL³



CASHMERE



HICKORY OAK



KENDAL OAK

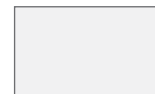

RAL 9003 WHITE



WHITE WITH HORIZONTAL STRUCTUR

EXTRA-COST OPTIONS:

Ventilation undercut / recuperation 15 mm

PVC ventilation sleeves

Ventilation sleeves steel - satin

Reverse door leaf

Non-rebated / passive / sliding door leaf

Third hinge (non-rebated door)

Third hinge (reverse door)

Size 100'

TETYDA

VENEER PANEL REBATED / NON-REBATED

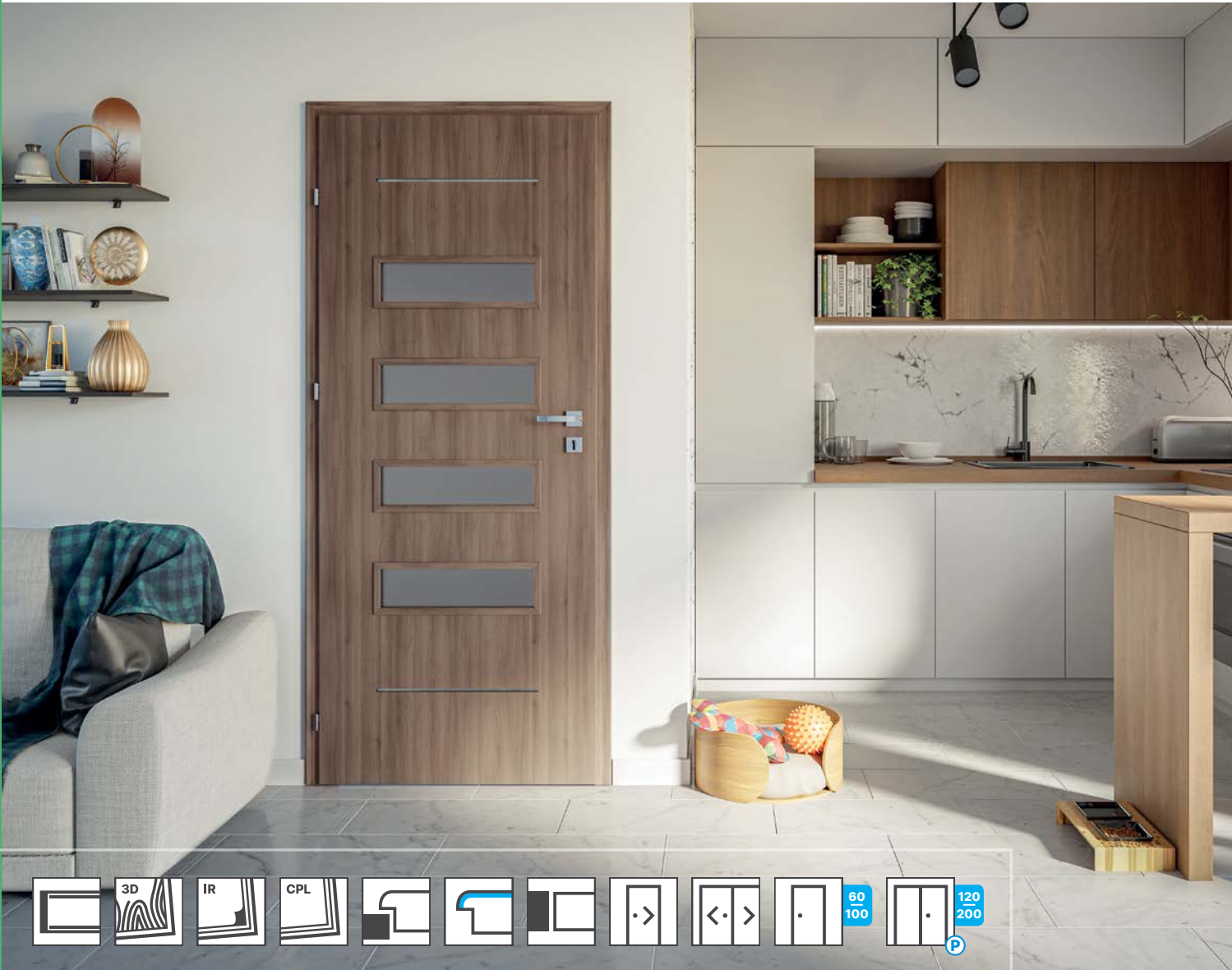

DOOR SPECIFICATION

- Hard Edge R door leaf edge profile for 3D Look and Iridium decors, Classen Hard construction / peripheral frame made of softwood
- Hard Edge PF door leaf edge profile for CPL decors, Classen Hard construction / peripheral frame made of MDF board, reinforced
- inlay: aluminium profile, width: 6 mm
- safety tempered Estriado glass, bronze satin, graphite satin

Rebated door leaf:

- two silver screw-in pintle hinges ¹
- lock: standard key lock / bathroom lock / cylinder lock / mortise lock

Non-rebated door leaf:

- available for Iridium and CPL decors
- Classen Hard construction / peripheral frame made of softwood
- two openings for 3D hidden hinges
- magnetic lock: standard key lock / bathroom lock / cylinder lock / mortise lock

RECOMMENDED DOOR FRAMES

Hard edge PF/R:

- adjustable door frames for rebated doors
- fixed door frame for rebated doors (except CPL Cashmere decor)

Hard edge B:

- adjustable non-rebated door frame

¹ | Door leaves 100' and reinforced door leaves regardless of the size - the set includes 3 hinges.



model 1

model 2

model 3

model 4

model 5

DETAILS



estriado glass



graphite satin glass



bronze satin glass



glazing frame



aluminium profile 6 mm

3D LOOK



SONOMA OAK



RIVIERA OAK



COLOMBIA LIGHT WALNUT



WHITE ASH



GREY OAK



OILED OAK

IRIDIUM



GRAPHITE ASH



GRANDSON OAK



MARRONE OAK

CPL



CASHMERE



NORWEGIAN ASH



GRIGIO OAK

CPL



KENDAL OAK



ITALIAN WALNUT



LIGHT ACACIA



RAL 9003 WHITE



WHITE WITH HORIZONTAL STRUCTUR

EXTRA-COST OPTIONS:

Ventilation undercut / recuperation 15 mm

PVC ventilation sleeves

Perforated chipboard

Non-rebated / passive / sliding door leaf

Third hinge (rebated door)

Third hinge (non-rebated door)

Size 100'

Glass satin brown, graphite

NATURA HR

VENEER PANEL REBATED

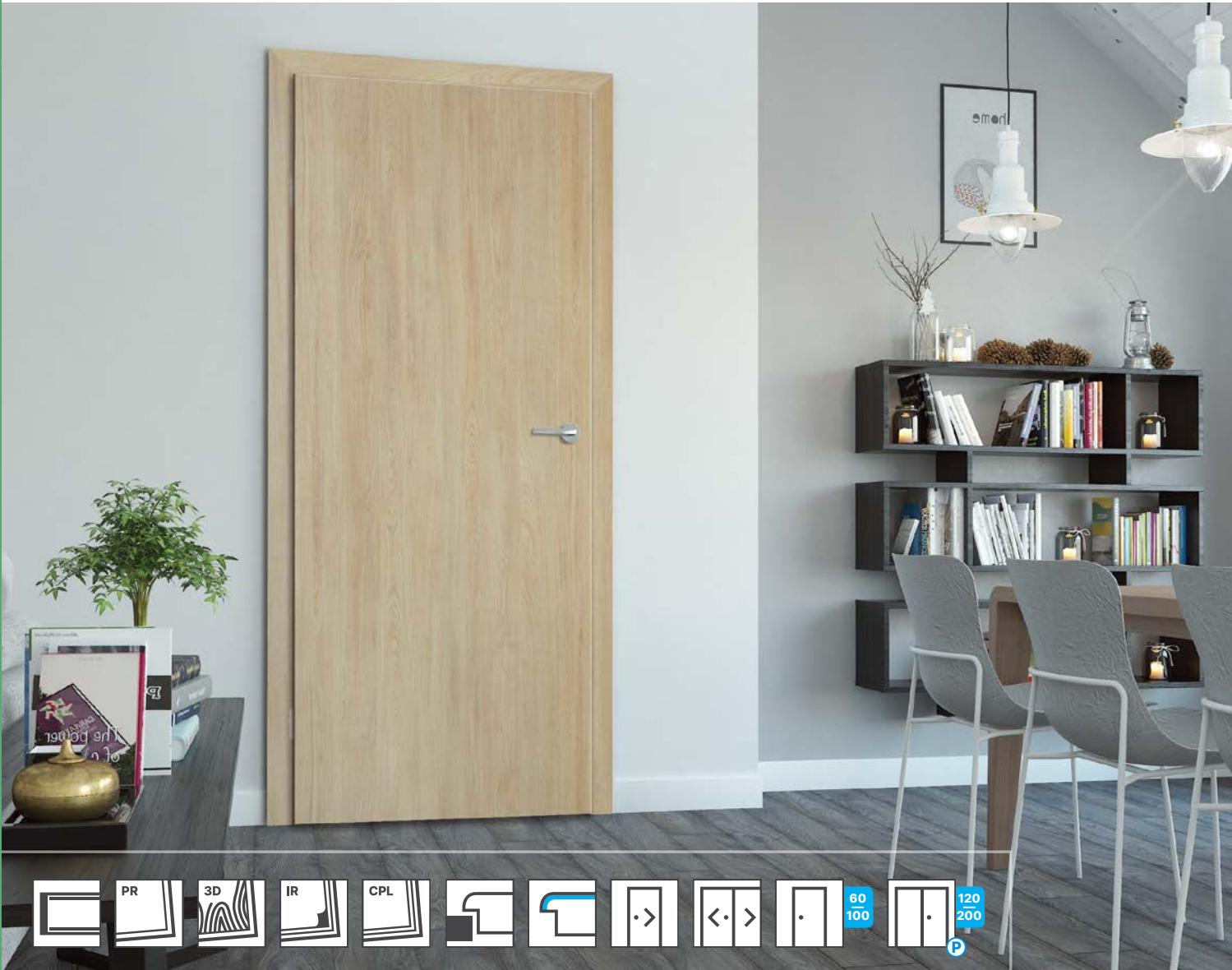

DOOR SPECIFICATION

Rebated door leaf:

- Hard Edge R door leaf edge profile for Primo, 3D Look and Iridium decors, Classen Hard construction / peripheral frame made of softwood
- Hard Edge PF door leaf edge profile for CPL decors, peripheral frame made of MDF board, reinforced, Classen Hard construction
- two silver screw-in pintle hinges ¹
- lock: standard key lock / bathroom lock / cylinder lock / mortise lock
- milky-white toughened safety glass

RECOMMENDED DOOR FRAMES

Hard edge R/PF:

- adjustable door frames for rebated doors
- fixed door frame for rebated doors (door frame for rebated doors (except Hamilton Oak decor)

¹ | Door leaves 100' and reinforced door leaves regardless of the size - the set includes 3 hinges.

² | Decor available only for model 1.



model 1 model 2 model 3 model 4 model 1 with porthole

Door leaf with a porthole is not available in sliding version, more on page 154.

DETAILS



milky-white toughened safety glass



OPTION / transparent glazing frame tempered glass



PRIMO



ACACIA ST



BEECH



WALNUT



SONOMA OAK



RIVIERA OAK



WHITE ASH

3D LOOK



COLOMBIA LIGHT WALNUT



OILED OAK



GREY OAK



GRAPHITE ASH



MARRONE OAK

IRIDIUM



HAMILTON OAK VERTICAL



NORWEGIAN ASH



GRIGIO OAK²



KENDAL OAK²

CPL



RAL 9003 WHITE



WHITE WITH HORIZONTAL STRUCTURE

EXTRA-COST OPTIONS:

Ventilation undercut / recuperation 15 mm

PVC ventilation sleeves

PVC ventilation grille

Full chipboard

Perforated chipboard

Passive / sliding door leaf

Third hinge (rebated door)

Size 100'

Transparent glass

Porthole - frosted glass, external diameter 350 mm, only for model 1

Aluminium profiles - Venom Alu

ANDROMEDA

VENEER PANEL REBATED / NON-REBATED

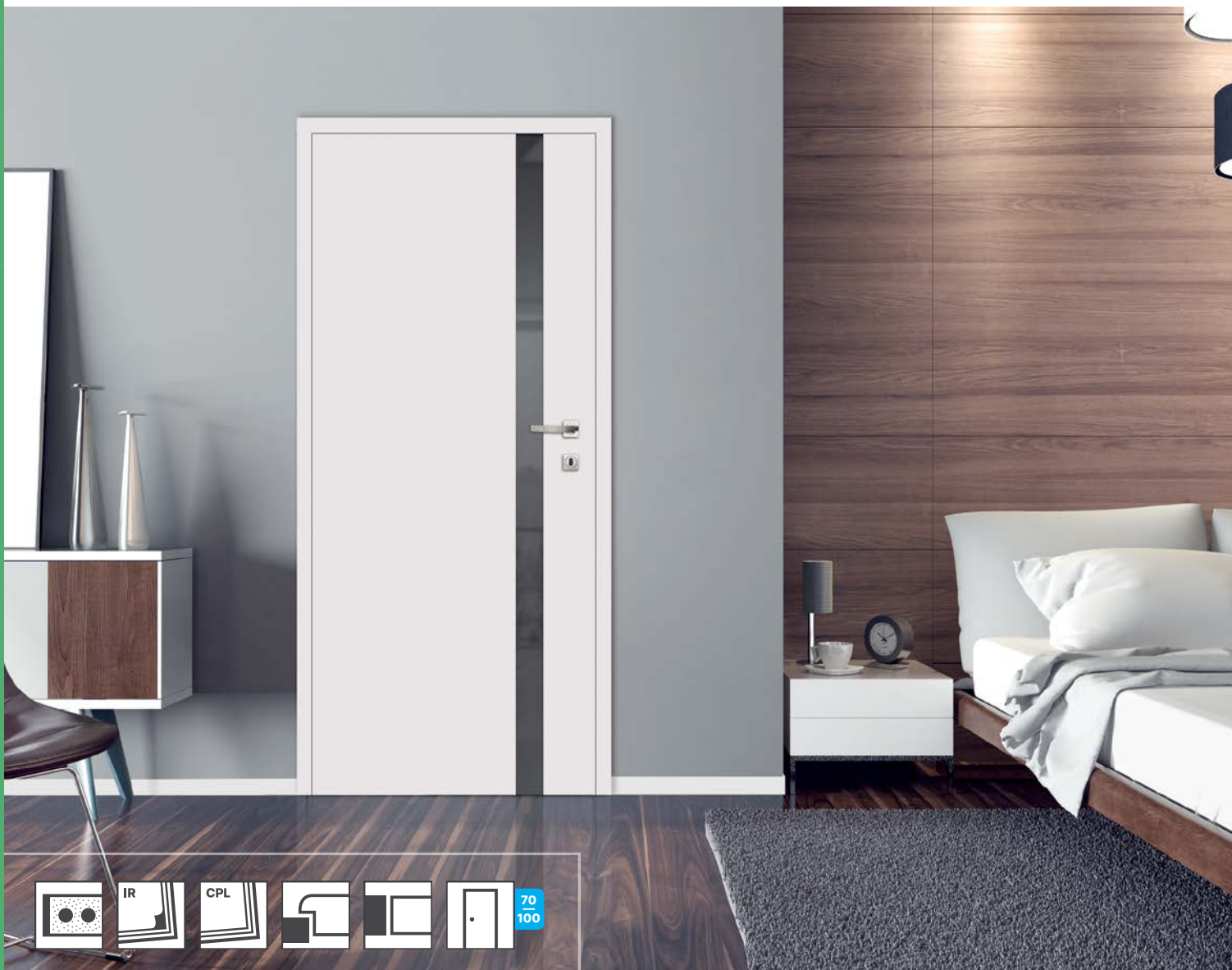

DOOR SPECIFICATION

- peripheral frame made of softwood
- milky-white toughened safety glass

Rebated door leaf:

- three silver screw-in pintle hinges
- lock: standard key lock / bathroom lock / cylinder lock / mortise lock

Non-rebated door leaf:

- two openings for 3D hidden hinges
- magnetic lock: standard key lock / bathroom lock / cylinder lock / mortise lock

RECOMMENDED DOOR FRAMES

Hard edge R:

- adjustable door frames for rebated doors
- fixed door frame for rebated doors (except Hamilton Oak, Hickory Oak, and Cashmere decors)

Hard edge B:

- adjustable non-rebated door frame



model 1

model 2

model 3

model 4

model 5

DETAILS



milky-white toughened safety glass



OPTION / graphite satin glass



ventilation undercut available for all models

IRIDIUM



GRAPHITE ASH



MARRONE OAK



GRANDSON OAK



LIGHT ACACIA



NORWEGIAN ASH

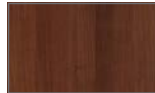

ITALIAN WALNUT



HICKORY OAK

CPL



CASHMERE



GRIGIO OAK



HAMILTON OAK VERTICAL



KENDAL OAK



RAL 9003 WHITE



WHITE WITH HORIZONTAL STRUCTUR

EXTRA-COST OPTIONS:

Ventilation undercut / recuperation 15 mm

Non-rebated door leaf

Third hinge (non-rebated door)

Size 100'

Graphite satin glass

DEMETER

VENEER PANEL REBATED



DOOR SPECIFICATION

- Hard Edge R door leaf edge profile for Primo, 3D Look and Iridium decors, Classen Hard construction / peripheral frame made of softwood
- Hard Edge PF door leaf edge profile for CPL decors, Classen Hard construction / peripheral frame made of MDF board, reinforced
- milky-white toughened safety glass

Rebated door leaf:

- two silver screw-in pintle hinges ¹
- lock: standard key lock / bathroom lock / cylinder lock / mortise lock
- **NOTE** – single leaf
 - 60'-100' (models 1 i 4)
 - 70'-100' (models 2, 3, 5)

RECOMMENDED DOOR FRAMES

Hard edge PF/R:

- adjustable door frames for rebated doors
- fixed door frame for rebated doors (except Hamilton Oak, Hickory Oak, and Cashmere decors)

¹ | Door leaves 100' and reinforced door leaves regardless of the size - the set includes 3 hinges.



model 1 model 2 model 3 model 4 model 5

DETAILS

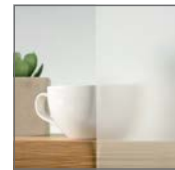

milky-white
toughened safety
glass



glazing frame

PRIMO



ACACIA ST WALNUT GREY MATT

3D LOOK



HONEY CATANIA GESSATO OAK CLEVELAND OAK

3D LOOK



SONOMA OAK OILED OAK GREY OAK RIVIERA OAK COLOMBIA LIGHT WALNUT WHITE ASH

IRIDIUM



GRAPHITE ASH GRANDSON OAK MARRONE OAK

CPL



CASHMERE HICKORY OAK NORWEGIAN ASH

CPL



HAMILTON OAK VERTICAL GRIGIO OAK KENDAL OAK ITALIAN WALNUT LIGHT ACACIA

EXTRA-COST OPTIONS:

Ventilation undercut / recuperation 15 mm

PVC ventilation sleeves

Perforated chipboard

Passive / sliding door leaf

Third hinge (rebated door)

Size 100'

CENTURY

VENEER PANEL REBATED

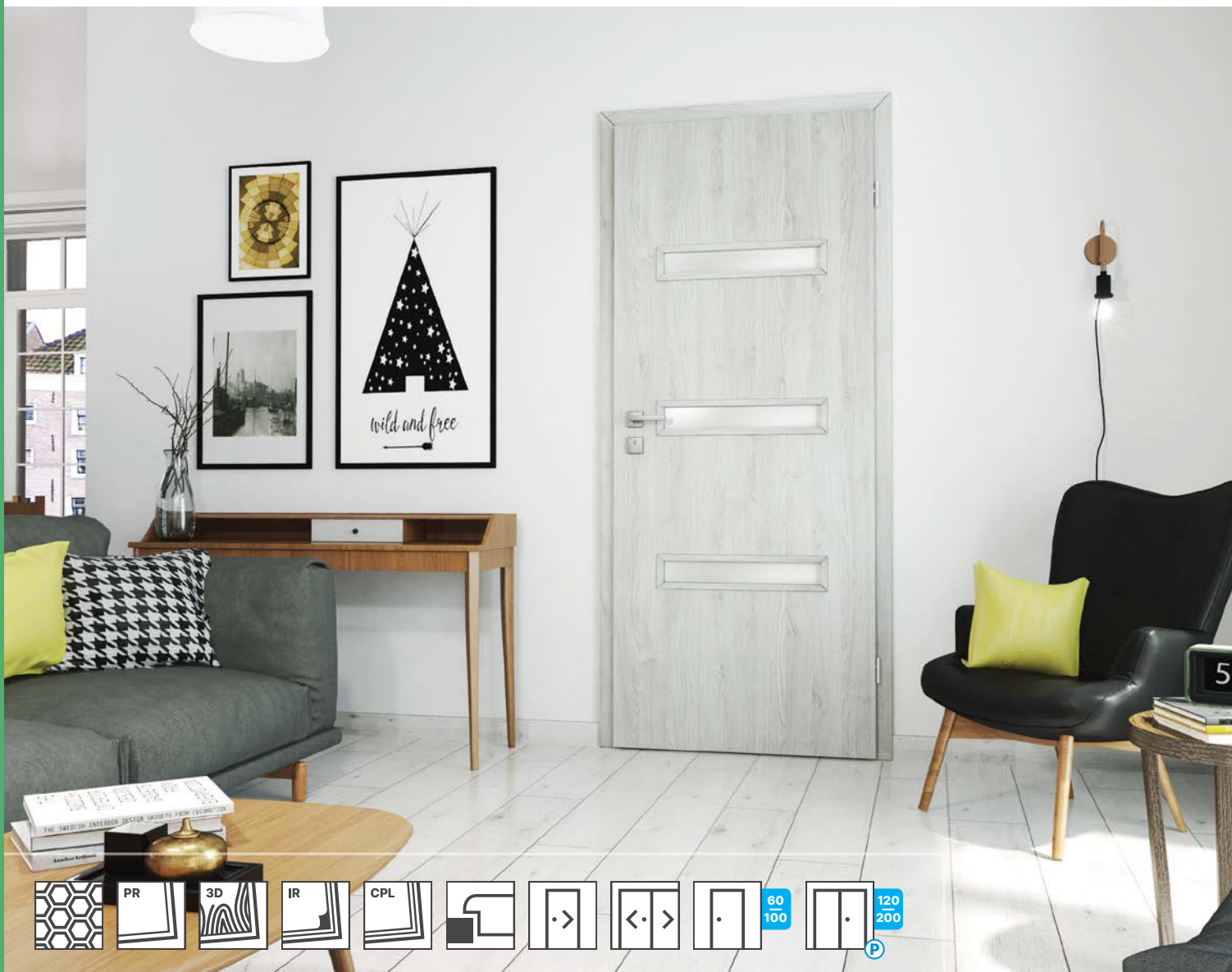

DOOR SPECIFICATION

- peripheral frame made of MDF board
- satin glass

Rebated door leaf:

- two silver screw-in pintle hinges ¹
- lock: standard key lock / bathroom lock / cylinder lock / mortise lock

RECOMMENDED DOOR FRAMES

Hard edge R:

- fixed and adjustable door frames for rebated doors

¹ | Door leaves 100' – the set includes 3 hinges.



DETAILS



satin glass

OPTION / bronze
satin glass

OPTION / graphite
satin glass

glazing frame

PRIMO



ACACIA ST



WALNUT



WHITE



GREY MATT

3D LOOK



HONEY CATANIA



GESSATO OAK

3D LOOK



CLEVELAND OAK



SONOMA OAK



RIVIERA OAK



COLOMBIA LIGHT
WALNUT



WHITE ASH

3D LOOK



OILED OAK



GREY OAK

IRIDIUM



GRAPHITE ASH



GRANDSON OAK



MARRONE OAK

CPL



NORWEGIAN ASH



ITALIAN WALNUT



LIGHT ACACIA

EXTRA-COST OPTIONS:

Ventilation undercut / recuperation 15 mm

PVC ventilation sleeves

Passive / sliding door leaf

Size 100'

Bronze or graphite satin glass for models 2, 3, 4

Bronze or graphite satin glass for models 6, 7

MALAGA

VENEER PANEL REBATED



DOOR SPECIFICATION

- peripheral frame made of MDF board
- milky-white toughened safety glass

Rebated door leaf:

- two silver screw-in pintle hinges ¹
- lock: standard key lock / bathroom lock / cylinder lock / mortise lock

RECOMMENDED DOOR FRAMES

Hard edge K:

- fixed and adjustable door frames for rebated doors

¹ | Door leaves 100' and reinforced door leaves regardless of the size - 3 hinges.



full

1/4 glazed

2/4 glazed

3/4 glazed

4/4 glazed

DETAILS



milky-white
toughened safety
glass



glazing frame

PRIMO



ACACIA ST



WALNUT



WHITE

3D LOOK



RIVIERA OAK



COLOMBIA LIGHT
WALNUT



WHITE ASH

3D LOOK



OILED OAK



GREY OAK



HONEY CATANIA



SONOMA OAK

IRIDIUM



GRAPHITE ASH



MARRONE OAK

EXTRA-COST OPTIONS:

PVC ventilation grille

PVC ventilation sleeves

Perforated chipboard

Passive / sliding door leaf

Third hinge (rebated door)

Size 100'

MODENA 4

VENEER PANEL REBATED



DOOR SPECIFICATION

- peripheral frame made of MDF board
- milky-white toughened safety glass

Rebated door leaf:

- two silver screw-in pintle hinges ¹
- lock: standard key lock / bathroom lock / cylinder lock / mortise lock

RECOMMENDED DOOR FRAMES

Hard edge K:

- fixed and adjustable door frames for rebated doors

¹ | Door leaves 100' and reinforced door leaves regardless of the size - 3 hinges.



full

1/4 glazed

3/4 glazed

4/4 glazed

DETAILS



milky-white
toughened safety
glass



glazing frame

PRIMO



ACACIA ST



WALNUT



WHITE

3D LOOK



RIVIERA OAK



COLOMBIA LIGHT
WALNUT



WHITE ASH

3D LOOK



GREY OAK



HONEY CATANIA



SONOMA OAK

IRIDIUM



GRAPHITE ASH



MARRONE OAK

EXTRA-COST OPTIONS:

PVC ventilation grille

PVC ventilation sleeves

Perforated chipboard

Passive / sliding door leaf

Third hinge (rebated door)

Size 100'

NATURA

VENEER PANEL REBATED



DOOR SPECIFICATION

- peripheral frame made of MDF board
- ornamental glass, transparent bark

Rebated door leaf:

- two silver screw-in pintle hinges ¹
- lock: standard key lock / bathroom lock / cylinder lock / mortise lock

RECOMMENDED DOOR FRAMES

Hard edge K:

- fixed and adjustable door frames for rebated doors

¹ | Door leaves 100' and reinforced door leaves regardless of the size - 3 hinges.

² | Decor available only for solid model.



full

1/3 glazed

2/3 glazed

3/3 glazed

DETAILS



ornamental glass,
transparent bark



glazing frame

PRIMO



ACACIA ST ²



BEECH



WALNUT



WHITE



GREY MATT ²

3D LOOK



RIVIERA OAK ²



HONEY CATANIA ²



COLOMBIA LIGHT
WALNUT



WHITE ASH



OILED OAK

3D LOOK



GREY OAK



SONOMA OAK



CLEVELAND OAK

EXTRA-COST OPTIONS:

PVC ventilation grille

PVC ventilation sleeves

Perforated chipboard

Passive / sliding door leaf

Third hinge (rebated door)

Size 100'

ANTIOPE

VENEER PANEL REBATED

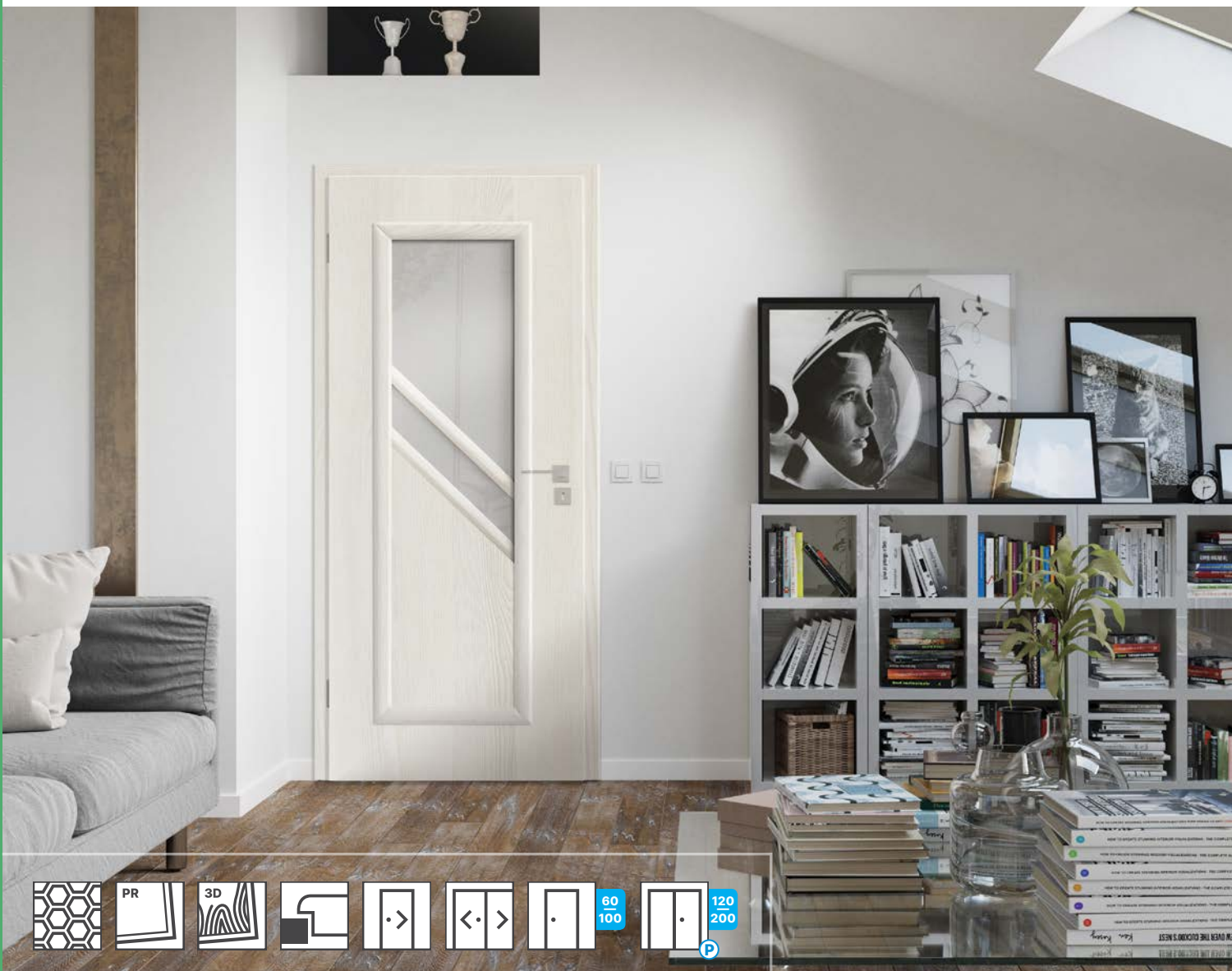

DOOR SPECIFICATION

- peripheral frame made of MDF board
- milky-white toughened safety glass

Rebated door leaf:

- two silver screw-in pintle hinges ¹
- lock: standard key lock / bathroom lock / cylinder lock / mortise lock

RECOMMENDED DOOR FRAMES

Hard edge R:

- fixed and adjustable door frames for rebated doors

¹ | Door leaves 100' and reinforced door leaves regardless of the size - 3 hinges.



model 1

model 2

model 3

DETAILS



milky-white
toughened safety
glass



glazing frame

PRIMO



ACACIA ST



WALNUT

3D LOOK



RIVIERA OAK



WHITE ASH



GREY OAK

EXTRA-COST OPTIONS:

PVC ventilation grille

PVC ventilation sleeves

Passive / sliding door leaf

Third hinge (rebated door)

SIDE PANEL

PASSIVE DOOR LEAF



A passive door leaf, commonly known as a "side panel", is used to widen the clear opening in places where there is no need or physical possibility to install full width double leaf doors.

The active leaf is used on a daily basis, while the passive leaf remains closed. If necessary, the passive part can be quickly opened, and a wider door opening can be used.

It is a very simple and useful solution that increases the functionality of your door.

DOOR SPECIFICATION

- veneer or lacquered passive door leaf
- construction: wooden peripheral frame
- two or three silver hinges
- adjustable strike plate and two shootbolts
- available only as a solid version without glazing

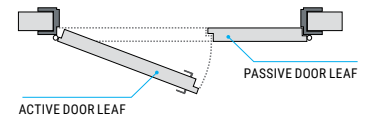

EXTRA-COST OPTIONS:

Third hinge (rebated door)

Reinforced with perforated chipboard

Reinforced with full chipboard



Find a door

PERFECTLY

**tailored to your needs
on our website.**

www.classen.pl



TECHNICAL PANEL DOORS



TECHNICAL PANEL DOORS

These are the doors for special tasks, and their high quality is confirmed by numerous certificates and approvals. Depending on the selected collection, they will perform different functions accordingly: they will ensure good sound insulation, fire protection or will constitute an additional protection against burglary. Moreover, their high functionality goes hand in hand with aesthetics - hence it is the ideal solution for public utility buildings, offices, hotels and restaurants.



FUNCTIONALITY OR APPEARANCE? You do not have to choose. No more compromises. Our technical doors have it all - excellent functional qualities and aesthetically pleasing design.



FOR OFFICES,
HOTELS AND
RESTAURANTS.
Wherever
high quality,
good technical
parameters
and solid
workmanship
are important.





model 1 model 2 model 3 model 4 model 5 model 6 model 7 m. 1 with additions, more on page 154.

DETAILS



milky-white toughened safety glass



OPTION / transparent glazing frame tempered glass



IRIDIUM



MARRONE OAK



UNI BLACK



GRAPHITE ASH



GRANDSON OAK

CPL

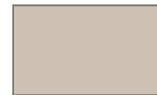

CASHMERE



HAMILTON OAK VERTICAL



HAMILTON OAK HORIZONTAL

CPL



HICKORY OAK



ITALIAN WALNUT



LIGHT ACACIA



NORWEGIAN ASH



GRIGIO OAK



KENDAL OAK



WHITE WITH HORIZONTAL STRUCTUR

CPL / HPL ⁷



RAL 9003 WHITE



RAL 7047 GREY ⁵



RAL 7024 GRAPHITE

EXTRA-COST OPTIONS:

GLAZING

Porthole 35 - frosted or transparent glass, external diameter 350 mm - model 1

Transparent glass for the following models: 2 - 7

CONSTRUCTION, SIZE

Door leaf 100'

Door leaf 110'

Door leaf 120'

Door leaf model 1, PN22

Door leaf model 1, PN23

Reverse door leaf

Non-rebated / passive / sliding door leaf

Third hinge (rebated door)

Third hinge (non-rebated door)

Third hinge (reverse door)

Perforated chipboard ²

Full chipboard ³

Aluminium profiles - Venom Alu

VENTILATION

Ventilation undercut

Ventilation undercut, 15 mm, designed for rooms with recuperation

PVC ventilation grille

Ventilation grille, aluminium

Double-sided steel kick-plate with ventilation grille

ACCESSORIES

Solid steel push-plate single-sided

Solid steel push-plate double-sided

Solid steel kick-plate single-sided

Solid steel kick-plate double-sided

Falling threshold

GUARD



70
110

DOOR SPECIFICATION

- reinforced plus construction, door leaf thickness - 40 mm
- door leaf edge protected with a stainless steel profile
- glazing frame made of stainless steel
- milky-white toughened safety glass, thickness: 4 mm
- three reinforced three-wing silver hinges
- cylinder lock
- reinforcement for door closer
- doors sold as a set with the door frame

RECOMMENDED DOOR FRAMES

Hard edge K:

- Guard steel fixed and adjustable door frame

ADDITIONAL INFORMATION

- other HPL decors (page 172) available upon individual enquiries: inwestycje@classen.com.pl
- additional information: possibility of executing custom door leaves, door frames and glasses upon individual requests: inwestycje@classen.com.pl

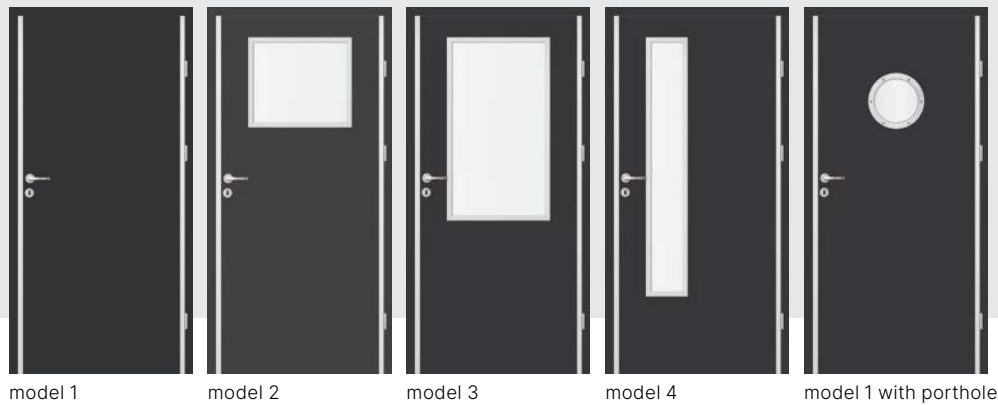

model 1

model 2

model 3

model 4

model 1 with porthole

DETAILS



three-wing hinge



rebate with stainless steel profile



porthole

IRIDIUM



MARRONE OAK



GRANDSON OAK



CASHMERE



HAMILTON OAK
VERTICAL



HAMILTON OAK
HORIZONTAL



ITALIAN WALNUT

CPL



LIGHT ACACIA



NORWEGIAN ASH



GRIGIO OAK



HICKORY OAK



KENDAL OAK



WHITE WITH
HORIZONTAL
STRUCTUR

CPL



RAL 9003 WHITE



RAL 7024 GRAPHITE

HPL *



RAL 9003 WHITE

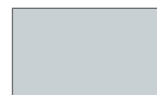

RAL 7047 GREY



RAL 7024 GRAPHITE

EXTRA-COST OPTIONS:

GLAZING

Porthole 35 - frosted or transparent glass, external diameter 350 mm - model 1

CONSTRUCTION, SIZE

* HPL decors

Door leaf 100'

Door leaf 110'

RAL 7024 steel door frame

VENTILATION

PVC ventilation grille

Ventilation grille, aluminium

Double-sided steel kick-plate with ventilation grille

ACCESSORIES

Solid steel push-plate
single-sided

Solid steel push-plate
double-sided

Solid steel kick-plate
single-sided

Solid steel kick-plate
double-sided

Stainless steel threshold 80', 90'

BORD

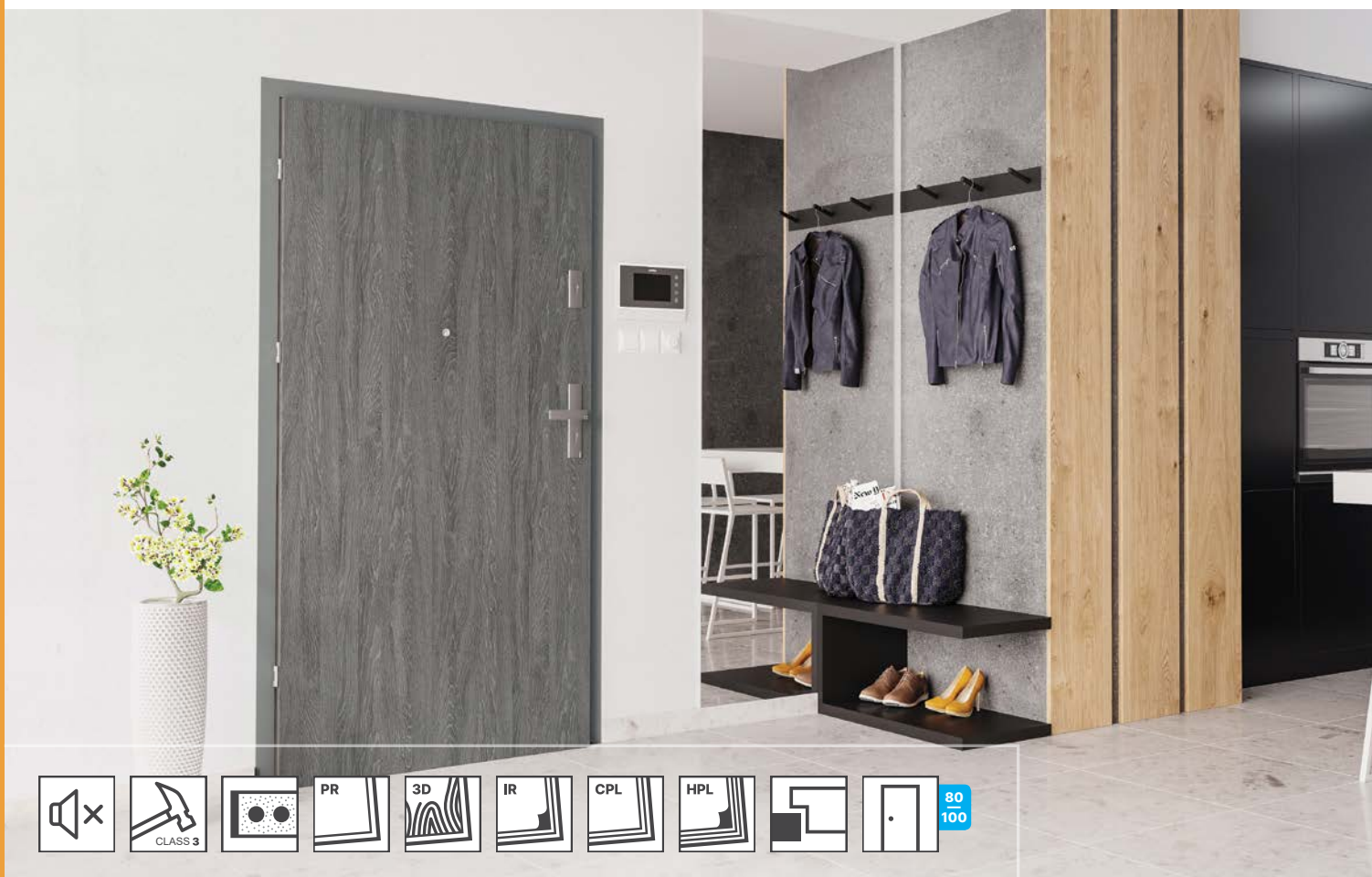

BORD internal entrance door is designed for use in residential housing, public utility and collective residential buildings.

DOOR SPECIFICATION

- acoustic resistance – 32 dB for B46 W2 and W46 W2 door
 - if BORD MDF fixed door frame is used
 - if BORD steel fixed door frame is used
- three silver adjustable double-pin screw-in pintle hinges
- leaf thickness:
 - B40 – 40 mm, B46 and W46 – 46 mm

RECOMMENDED DOOR FRAMES

- BORD MDF fixed (except Cashmere, Hamilton Oak, and Hickory Oak decors)
- BORD steel fixed
- BORD steel corner
- HYBRYDA (except Cashmere, Hamilton Oak, and Hickory Oak decors)

ADDITIONAL INFORMATION

- spacing of holes in the lock:
 - lower deadbolt lock – 90 mm (B)
 - multipoint lock – 72 mm (W)
- lock cylinders and door handles do not constitute door leaf equipment

ADDITIONAL INFORMATION

- lock cylinder size:
 - B40 – 26/36, B46 and W46 – 26/40
- technical approval: AT – 15-8467/2016
- possibility of executing custom doors and door frames upon individual requests: inwestycje@classen.com.pl
- other HPL decors available upon individual enquiries: inwestycje@classen.com.pl
- decors not included in the standard offer are available with a rebate in brushed aluminium colour

	B40 W1	B46 W1	B46 W2	W46 W1	W46 W2
reinforced peripheral frame made of softwood	✓	✓	✓	✓	✓
steel flat bars		✓	✓	✓	✓
perforated chipboard	✓	✓	✓	✓	✓
two bolt locks for lock cylinder	✓	✓	✓		
multipoint lock for cylinder lock				✓	✓
falling threshold and three anti-burglary bolts			✓		✓



model 1

steel panel with room number (option)

DETAILS



bottom bolt lock

top bolt lock

anti-burglary bolt

falling threshold

PRIMO



ACACIA ST



WALNUT

3D LOOK



HONEY CATANIA



GESSATO OAK



CLEVELAND OAK



SONOMA OAK

3D LOOK



RIVIERA OAK



COLOMBIA LIGHT WALNUT



WHITE ASH



OILED OAK



GREY OAK



GRANDSON OAK

IRIDIUM

IRIDIUM



MARRONE OAK



GRAPHITE ASH



HICKORY OAK



CASHMERE



HAMILTON OAK VERTICAL



HAMILTON OAK HORIZONTAL

CPL

CPL



ITALIAN WALNUT



LIGHT ACACIA



NORWEGIAN ASH



GRIGIO OAK



KENDAL OAK



WHITE WITH HORIZONTAL STRUCTUR

CPL



RAL 9003 WHITE



RAL 7024 GRAPHITE



RAL 9003 WHITE



RAL 7047 GREY



RAL 7024 GRAPHITE

HPL *

EXTRA-COST OPTIONS:

CONSTRUCTION

Door leaf 100'

FINISH

* HPL decors

Venom milling patterns

Aluminium profiles – Venom Alu

ACCESSORIES

View-finder – nickel, bronze

View-finder – black

Falling threshold

Steel panel with room number
– single-sided

BORD W3

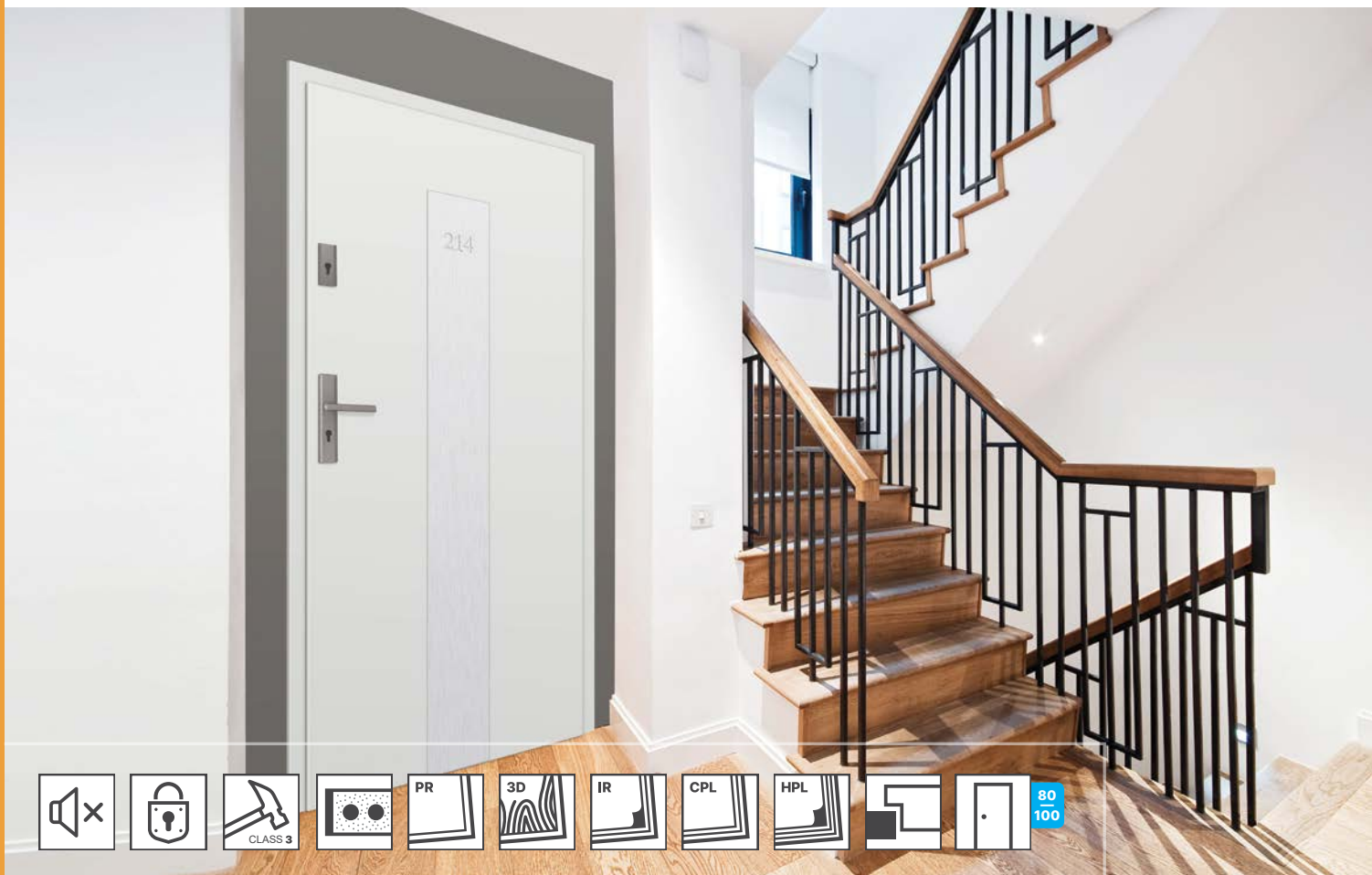

BORD W3 internal entrance door meet the requirements of the RC2 anti-burglary protection class, provided that the door is installed with a dedicated steel door frame (page 146), handle with escutcheon (page 165) and a set of cylinder locks meeting the requirements of the second anti-burglary class (page 158).

Construction of a door leaf with thickness of 46 mm: peripheral frame made of softwood reinforced with special steel flat bar and a plywood. A perforated chipboard was used as a core. All is covered with wood-based board, veneered with Classen decors.

DOOR SPECIFICATION

- three anti-burglary three-way silver hinges
- Multistrong multi-point strip lock
- multipoint lock for cylinder lock (openings spacing: 72 mm)
- leaf thickness: 46 mm
- door leaf available only with BORD W3 steel fixed door frame (page 146)

RECOMMENDED DOOR FRAMES

- BORD W3 STEEL FIXED

ADDITIONAL INFORMATION

- other HPL decors available upon individual enquiries: inwestycje@classen.com.pl
- decors not included in the standard offer are available with a rebate in brushed aluminium colour



model 1

steel panel with room number (option)

DETAILS

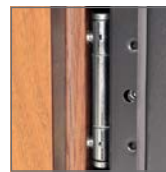

three-wing hinge

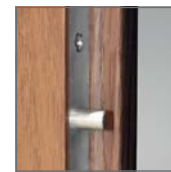

interlocking door bolts strip



multipoint lock bolts strip

PRIMO



ACACIA ST



WALNUT

3D LOOK



HONEY CATANIA



GESSATO OAK



CLEVELAND OAK



SONOMA OAK

3D LOOK



RIVIERA OAK



COLOMBIA LIGHT WALNUT



WHITE ASH



OILED OAK



GREY OAK



GRANDSON OAK

IRIDIUM

IRIDIUM



MARRONE OAK



GRAPHITE ASH

CPL



HICKORY OAK

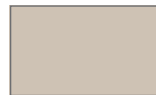

CASHMERE



HAMILTON OAK VERTICAL



HAMILTON OAK HORIZONTAL

CPL

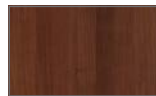

ITALIAN WALNUT



LIGHT ACACIA



NORWEGIAN ASH



GRIGIO OAK



KENDAL OAK



WHITE WITH HORIZONTAL STRUCTUR

CPL



RAL 9003 WHITE



RAL 7024 GRAPHITE

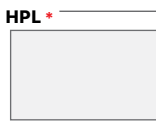

RAL 9003 WHITE



RAL 7047 GREY

HPL *



RAL 9003 WHITE



RAL 7047 GREY



RAL 7024 GRAPHITE

EXTRA-COST OPTIONS:

CONSTRUCTION

Door leaf and door frame 100'

FINISH

RAL 7024 steel door frame

* HPL decors

Venom milling patterns

Aluminium profiles – Venom Alu

ACCESSORIES

View-finder – nickel, bronze

View-finder – black

Falling threshold

Stainless steel threshold 80', 90'

Steel panel with room number
– single-sided

EI30 / EI60 FIRE DOORS

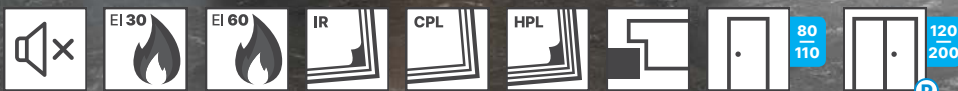
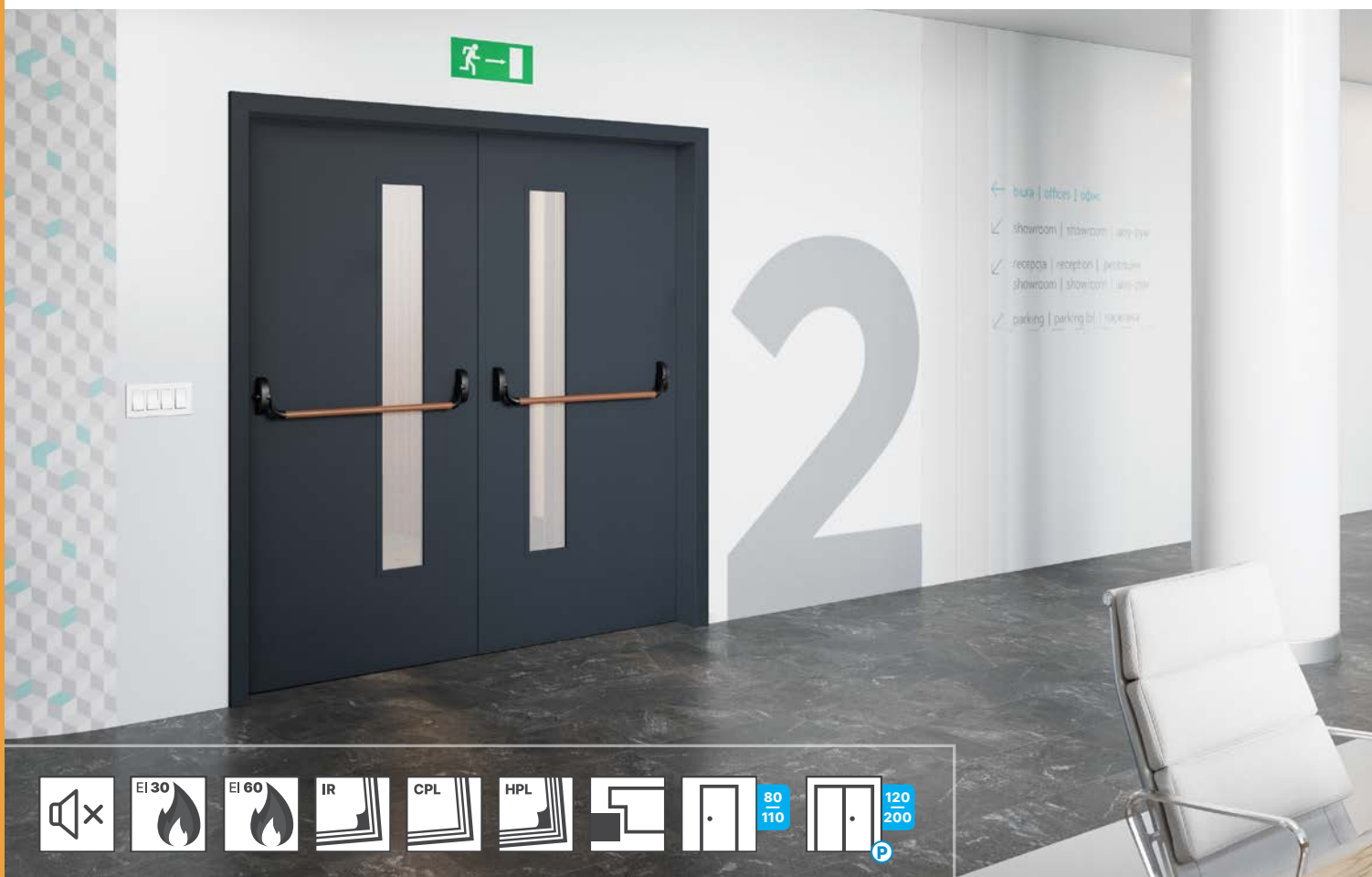

Internal entrance fire door is designed for use in residential housing, public utility and collective residential buildings as the door fulfilling the requirements for EI30 or EI60 fire resistance class, Sa and Sm smoke tightness class and acoustic resistance up to 32 dB.

DOOR SPECIFICATION

- special two-layer board / peripheral frame made of softwood
- mortise latch lock for cylinder lock with insulation insert
- falling threshold – W2 version
- Hard Edge K door edge profile
- surface finish with Classen laminate: Iridium, CPL, HPL
- expanding seal in door leaf rebate
- four silver pintle hinges
- single leaf – acoustic resistance version W2: 32 dB
- double leaf – acoustic resistance version W2: 27 dB for EI 30, 32 dB for EI 60
- leaves thickness: EI 30 – 50 mm, EI 60 – 60 mm
- in glazed version: transparent glass with higher fire resistance class
- openings spacing in the lock: 72 mm
- EI 60 door leaf available with steel fixed door frame upon individual enquiries
- doors sold as a set with the door frame

RECOMMENDED DOOR FRAMES

- FIRE wooden fixed door frame (except Hamilton Oak, Hickory Oak, and Cashmere decors)
- FIRE wooden adjustable fixed door frame, adjustment set, each item to be purchased separately (except Hamilton Oak, Hickory Oak, and Cashmere decors)
- FIRE steel fixed door frame

ADDITIONAL INFORMATION

- **Version W1** – does not have Sa, Sm smoke tightness class and acoustic resistance (falling threshold)
- national technical approval: ITB-KOT-2018/0407 2nd edition
- national declaration of constancy of performance: AC 158-UWB-W4060

ADDITIONAL INFORMATION

- in order to meet the technical requirements, fire door must be purchased together with a door closer
- internal entrance doors only in solid version
- cylinder locks and door handles do not constitute door leaf equipment
- cylinder locks size: EI 30 – 36x36; EI 60 – 36x46 (for handle escutcheons with a thickness of approx. 10 mm)
- size 91 and 101 meets the technical requirements for light opening width
- possibility to execute custom width and height of single and double door leaves upon individual enquiry: inwestycje@classen.com.pl

¹ | HPL decors: door frames for HPL decors available in Iridium or CPL veneer. Differences in shade are permissible. Other HPL decors (page 172) available upon individual enquiries: inwestycje@classen.com.pl (Decors outside the standard range are offered with the rebate in brushed aluminium colour.)

² | Dedicated door frame in the following decors:
 – Hickory Oak – Tocanis Oak (3D LOOK)
 – Hamilton Oak vertical / horizontal – Riviera Oak (3D LOOK)
 – Cashmere – UNI Cashmere (IRIDIUM)

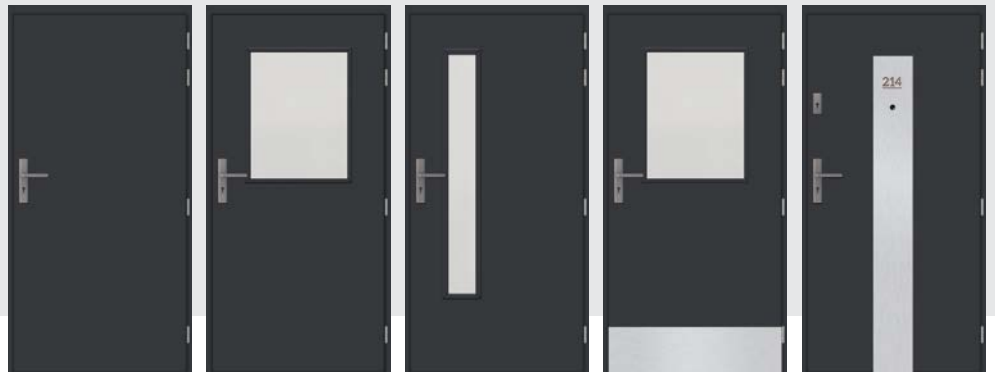

model 1 – EI30/EI60 model 2 – EI30/EI60 model 3 – EI30 model 2 – with steel kick-plate model 1 – with steel panel with room number

DETAILS



falling threshold



pintle hinge of rebated door with 3D regulation



DC 135 door closer with slide rail



DC140 surface-mounted door closer with standard arm

IRIDIUM



GRAPHITE ASH



GRANDSON OAK



MARRONE OAK



HICKORY OAK ²



ITALIAN WALNUT



NORWEGIAN ASH

CPL



HAMILTON OAK VERTICAL ²



HAMILTON OAK HORIZONTAL ²



GRIGIO OAK



KENDAL OAK



WHITE WITH HORIZONTAL STRUCTUR



RAL 9003 WHITE

CPL

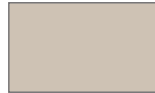

CASHMERE ²

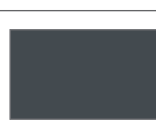

RAL 7024 GRAPHITE

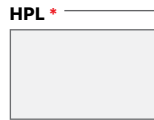

RAL 9003 WHITE ¹



RAL 7047 GREY ¹

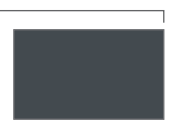

RAL 7024 GRAPHITE ¹

HPL *

EXTRA-COST OPTIONS:

CONSTRUCTION, SIZE

Door leaf 100', 101'

Door leaf 110'

FINISH

* HPL decors

Venom milling patterns

Aluminium profiles – Venom Alu

RAL 7024 steel door frame

ACCESSORIES

Stainless steel threshold 80', 90'

Falling threshold (for version W1)

Steel vertical panel with number, single-sided

Solid steel push-plate single-sided

Solid steel push-plate double-sided

Solid steel kick-plate single-sided

Solid steel kick-plate double-sided

Steel kick-plate with ventilation grille, double-sided 70'-90'

Plate for an averse/reverse electric strike in the door frame

Latch for a reverse electric strike in the door frame

EI30 / 42 dB **ACOUSTIC DOORS**



EI30 42 dB FIRE DOORS

DOOR SPECIFICATION

- construction: peripheral frame made of softwood with specialized board core, all covered with HDF board, leaf thickness: 57 mm
- cylinder lock, spacing: 72 mm
- single leaf 70'-100'
- falling threshold
- expanding seals
- mechanical resistance class 3 (acc. to PN-EN 1192:2001)

K rebated door leaf: ¹

- 4 pintle hinges
- additional seal in the rebate
- dedicated door frame: Fixed MDF 42db
- smoke tightness

B non-rebated door leaf: ¹

- 4 hidden hinges
- dedicated door frame: Fixed non-rebated MDF 42dB

42 dB ACOUSTIC DOORS

DOOR SPECIFICATION

- veneered door leaf
- construction: peripheral frame made of softwood with specialized board core, all covered with HDF board, leaf thickness: 57 mm
- cylinder lock, spacing: 72 mm
- single leaf 60'-100'
- falling threshold
- mechanical resistance class 3 (acc. to PN-EN 1192:2001)

K rebated door leaf: ¹

- 4 pintle hinges
- additional seal in the rebate
- dedicated door frame: Fixed MDF 42db

B non-rebated door leaf: ¹

- 4 hidden hinges
- dedicated door frame: Fixed non-rebated MDF 42dB

ADDITIONAL INFORMATION

- national declaration of constancy of performance: AC 158-UWB-W4061
- door can be used as entrance door
- in order to meet the technical requirements, fire door must be installed together with a door closer
- cylinder locks size 36/46 for rebated and non-rebated door leaves (for handle escutcheons with a thickness of approx. 10 mm)
- other HPL decors available upon individual enquiries: inwestycje@classen.com.pl
- decors not included in the standard offer are available with a rebate in brushed aluminium colour

¹ | Acoustic resistance: rebated: $R_w(C;Ctr)=44 (-2;-6)$ dB; non-rebated: $R_w(C;Ctr)=44 (-2;-5)$ dB

² | HPL decors: door frames for HPL decors available in Iridium or CPL veneer. Differences in shade are permissible.

³ | Dedicated door frame, 42dB fixed rebated and 42dB fixed non-rebated in the following decors:
 – Hickory Oak – Tocanis Oak (3D LOOK)
 – Hamilton Oak vertical / horizontal – Riviera Oak (3D LOOK)
 – Cashmere – UNI Cashmere (IRIDIUM)



fire door
rebated Ei30 42 dB /
rebated – 42 dB



rebated door
rebate profile



rebated door lock



rebated door 3D
pintle hinge



non-rebated door
rebate profile



non-rebated door
lock



non-rebated door
hidden hinge

DETAILS



falling threshold



DC 840 covered door closer with
slide rail (non-rebated door)



DC 135 door closer with slide rail
(rebated door)

IRIDIUM



GRAPHITE ASH



GRANDSON OAK



MARRONE OAK

CPL



HICKORY OAK ³

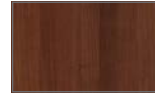

ITALIAN WALNUT



LIGHT ACACIA

CPL



HAMILTON OAK
VERTICAL ³



HAMILTON OAK
HORIZONTAL ³



NORWEGIAN ASH



GRIGIO OAK



KENDAL OAK



WHITE WITH
HORIZONTAL
STRUCTUR

CPL



RAL 9003 WHITE

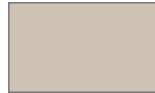

CASHMERE ³



RAL 7024 GRAPHITE

HPL *



RAL 9003 WHITE ²

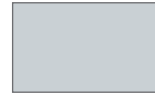

RAL 7047 GREY ²



RAL 7024 GRAPHITE ²

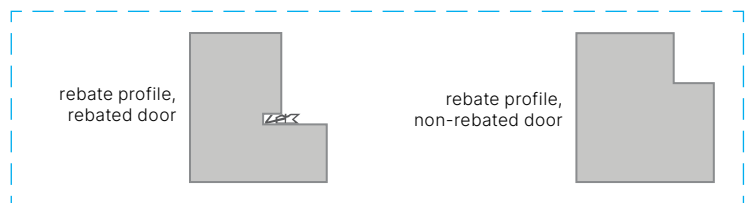

EXTRA-COST OPTIONS:

CONSTRUCTION, SIZE

Door leaf and door frame 100'

FINISH

* HPL decors

ACCESSORIES

Steel panel with room number, single-sided

Solid steel push-plate
single-sided

Solid steel push-plate
double-sided

Solid steel kick-plate
single-sided

Solid steel kick-plate
double-sided

VENOM

TECHNICAL PANEL DOORS – MILLING



OPTIONAL MILLING PATTERNS AVAILABLE FOR BORD, BORD W3 AND FIRE DOOR COLLECTIONS

NOTE

- Available as an extra-cost option for solid models from the BORD, BORD W3 and FIRE door collections.





model 3

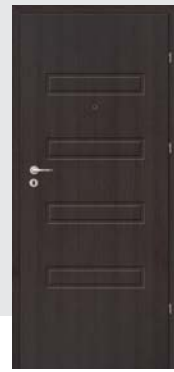

model 6



model 7



model 8



model 9



model 10



model 11

PRIMO



ACACIA ST

3D LOOK



COLOMBIA LIGHT
WALNUT



OILED OAK



SONOMA OAK

EXTRA-COST OPTIONS:

for solid models from the following collections::
BORD, BORD W3, FIRE DOORS

PR, 3D

VENOM ALU



OPTIONAL ALUMINIUM INSERT FINISHES FOR THE BORD, BORD W3, FIRE, NATURA HK/HB AS WELL AS NATURA HR COLLECTIONS

NOTE

- Available as an extra-cost option for solid models from the BORD, BORD W3, FIRE, Natura HK/HB, and Natura HR door collections (in selected decors, with construction reinforced with perforated chipboard only). Aluminium profile, width: 8 mm (colour - stainless steel / INOX), aligned with the door leaf surface.

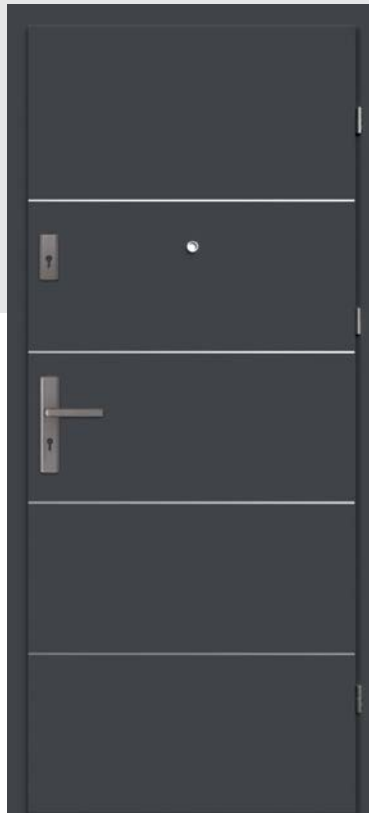

model 1



model 3



model 4



model 5



model 6

DETAILS



aluminium profile
8 mm

IRIDIUM



GRAPHITE ASH



GRANDSON OAK



MARRONE OAK



HICKORY OAK

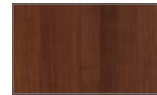

ITALIAN WALNUT



LIGHT ACACIA



NORWEGIAN ASH

CPL

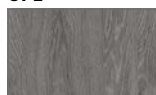

GRIGIO OAK



KENDAL OAK



HAMILTON OAK
VERTICAL



HAMILTON OAK
HORIZONTAL

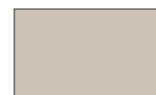

CASHMERE



RAL 7024 GRAPHITE

HPL



RAL 9003 WHITE



RAL 7047 GREY



RAL 7024 GRAPHITE

EXTRA-COST OPTIONS:

for solid models from the following collections:
BORD W3, BORD, FIRE DOORS,
NATURA HK/HB, NATURA HR

IR, CPL, HPL

ACOUSTIC DOORS



SOLID: 27 dB – Rw (27–30)

DOOR SPECIFICATION

- peripheral frame made of softwood, covered with HDF board
- 3 silver screw-in pintle hinges
- lock: standard key lock / bathroom lock / cylinder lock / mortise lock
- falling threshold

RECOMMENDED DOOR FRAME

- Adjustable door frame
Rw (C; Ctr)= 30(-1; -1) dB

SOLID: 32 dB – Rw (32–34)

DOOR SPECIFICATION

- specialized board, peripheral frame made of softwood, covered with HDF board
- 3 silver screw-in pintle hinges
- lock: standard key lock / bathroom lock / cylinder lock / mortise lock
- falling threshold

RECOMMENDED DOOR FRAME

- Adjustable door frame
Rw (C; Ctr)= 34 (-1; -2) dB
- Steel fixed door frame
Rw (C; Ctr)= 32 (0;-1) dB

WITH GLAZING: 32 dB – Rw (32–33)

DOOR SPECIFICATION

- safety transparent glass
- specialized board, peripheral frame made of softwood, covered with HDF board
- 3 silver screw-in pintle hinges
- lock: standard key lock / bathroom lock / cylinder lock / mortise lock
- falling threshold

RECOMMENDED DOOR FRAME

- Adjustable door frame
Rw (C; Ctr)= 32 (0;-2) dB
- Steel fixed door frame
Rw (C; Ctr)= 33 (0;-2) dB

ADDITIONAL INFORMATION

- acoustic resistance 27 dB (27-30 dB).
Report from GLA-1144.3/13 examinations.
- acoustic resistance 32 dB (32-34 dB).
Report from GLA-1166.2/14.a examinations.



model 1 – 27 dB

model 1 – 32 dB

model 2 – 32 dB

model 3 – 32 dB



Classen acoustic doors are available in all decors from the following groups: Primo, 3D Look, Iridium (except UNI decors), CPL, HPL (details on page 166).

EXTRA-COST OPTIONS:

Size 100'



DOORS ALIGNED WITH THE WAL

DOORS ALIGNED WITH THE WALL

This is the perfect choice for those looking for original solutions. No frames, hidden door frame and hinges, and a door leaf make this door perfectly blend with the wall. Thanks to this your room will turn into a mysterious casket, where the presence of the door can only be revealed by a discreet outline of the handle. Or maybe you want to experiment in a completely different style? This type of door may as well be distinguished by the original colour, bringing to mind an abstract painting filling the wall.



COMPACT

DOORS ALIGNED WITH THE WALL

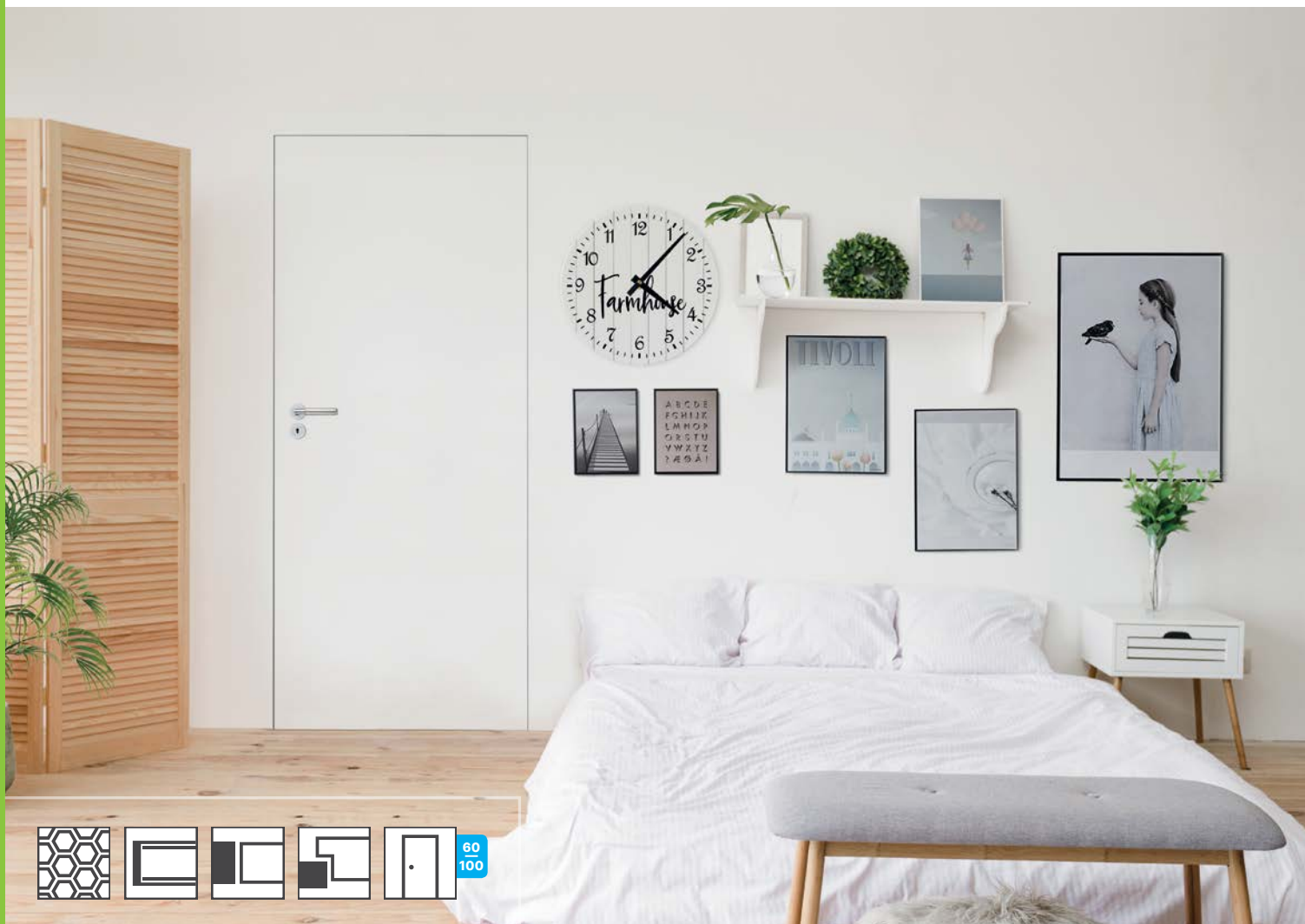

The Compact system consists of interior door leaf, veneered or for self-finishing and an aluminium door frame. After installation, the entire system forms a uniform surface with the wall.

DOOR SPECIFICATION

- panel door leaf, solid, thickness: 40 mm
- external door leaf – non-rebated, opening outwards (height 2022 mm)
- internal door leaf – rebated, opening inwards (height 2032 mm)
- surface finishing: primer (surface prepared for self-finishing – painting 1), 3D Look and Iridium veneers, CPL and HPL laminates
- two openings for hidden hinges, adjustable (3 hinges for the width of 100' and height from 2222 to 2332 mm)
- magnetic lock: standard key lock / bathroom lock / cylinder lock / mortise lock

RECOMMENDED DOOR FRAMES

Aluminium door frame:

- The frame is available in an external and internal version, raw, with the possibility of self-painting after impregnation.
- The package includes: 2 or 3 hinges, gaskets, impregnating agent, installation instruction and accessories needed for its installation.
- Installation of the door frame on a raw wall requires application of plaster or drywall.

¹ Tests conducted using original wall paints available on the market.

Classen doors in the Compact system are available in all decors from the following groups: Primo, 3D Look, Iridium (except UNI decors), CPL, HPL, lacquered (details on pages 166–169).



INTERNAL DOOR FRAME

DOOR LEAF HEIGHT H_d	MOUNTING OPENING HEIGHT H_o	DOOR LEAF EXTERNAL HEIGHT H_z	CLEAR OPENING HEIGHT H_p	NUMBER OF HINGES
2032	2081	2074	2032	2
2132	2181	2174	2132	2
2232	2281	2274	2232	3
2332	2381	2374	2332	3

DOOR LEAF WIDTH S_d	MOUNTING OPENING WIDTH S_o	DOOR LEAF EXTERNAL WIDTH S_z	DOOR LEAF CLEAR OPENING WIDTH S_p
618	698	688	603
718	798	788	703
818	898	888	803
918	998	988	903
1018	1098	1088	1003

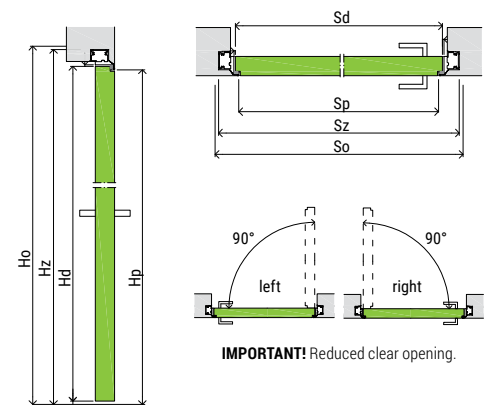
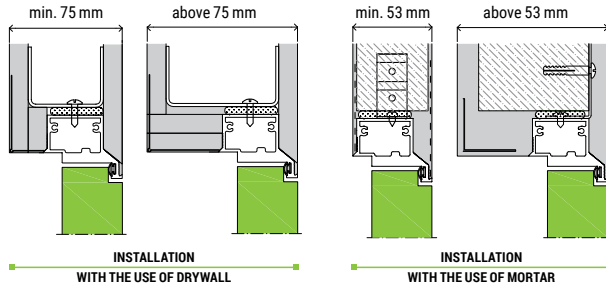

EXTERNAL DOOR LEAF

DOOR LEAF HEIGHT H_d	MOUNTING OPENING HEIGHT H_o	DOOR LEAF EXTERNAL HEIGHT H_z	CLEAR OPENING HEIGHT H_p	NUMBER OF HINGES
2022	2071	2064	2022	2
2122	2171	2164	2122	2
2222	2271	2264	2222	3
2322	2371	2364	2322	3

DOOR LEAF WIDTH S_d	MOUNTING OPENING WIDTH S_o	DOOR LEAF EXTERNAL WIDTH S_z	DOOR LEAF CLEAR OPENING WIDTH S_p
618	698	688	603
718	798	788	703
818	898	888	803
918	998	988	903
1018	1098	1088	1003

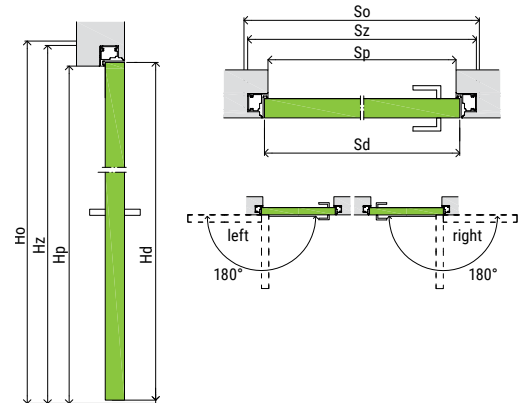
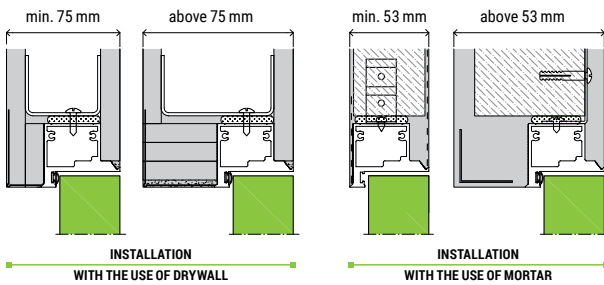

EXTRA-COST OPTIONS:

CONSTRUCTION

Perforated chipboard

Width 100' door leaf and door frame

Height H=2122, 2132 mm door leaf and door frame

Height H=2222, 2232 mm door leaf and door frame

Height H=2322, 2332 mm door leaf and door frame

VENTILATION

Ventilation undercut

Ventilation undercut, 15 mm, designed for rooms with recuperation

ACCESSORIES

Falling threshold



SLIDING DOOR SYSTEMS

SLIDING DOOR SYSTEMS

A way to create an original entrance to the room. They ensure comfortable use and freedom of movement. They are perfect for small spaces, where using traditional doors is a really hard task. They also do a great job on a larger surface, catching the eye and giving the interior a modern, dynamic character. They are available in single and double leaf versions. They also differ depending on the installation method – they can be retracted into the wall or intended for on-wall mounting. Leaves can be chosen from many models with different aesthetics, which is why everyone will find an option ideally suited to their interior.



DO YOU WANT TO SAVE SOME SPACE IN THE FLAT?

Sliding doors will help you with that. Thanks to the convenient way of opening and closing, they do not use additional space. Especially recommended for interiors where every centimetre is important.

NON-OBVIOUS DECORATION.

The door can play the first fiddle in interior design. Especially double leaf models that look very impressive. In spacious rooms they will hit the bullseye.



ON-WALL SLIDING DOOR SYSTEM



DOUBLE LEAF SLIDING DOOR SYSTEM

SINGLE LEAF SLIDING DOOR SYSTEM

- Single leaf on-wall sliding door system consists of a sliding mechanism, masking element (including a bumper beam) and a door leaf. Each element must be purchased separately.
- As a standard, the system is installed directly on the wall, optionally it can be installed with a tunnel frame, which must be purchased separately. Wall opening height for installation with the tunnel: 2060 mm, for installation without the tunnel: 2022 mm.
- Single leaf mechanism is equipped with a 2.5 m long rail, which should be cut to the final size.
- Single leaf sliding door system is offered in the following sizes: 60', 70', 80', 90', 100'.

DOUBLE LEAF SLIDING DOOR SYSTEM

- Double leaf on-wall sliding door system consists of a sliding mechanism, masking element and a door leaf. Each element must be purchased separately.
- Double leaf on-wall sliding door system is opened synchronously, i.e. by sliding one leaf, both door leaves open at the same time. Synchronous system requires ordering two door leaves of the same width.
- Double leaf mechanism is equipped with two 2.5 m long rails and masking elements, which should be cut to the final size.

- As a standard, the system is installed directly on the wall, optionally it can be installed with a tunnel frame, which must be purchased separately. Wall opening height for installation with the tunnel: 2060 mm, for installation without the tunnel: 2022 mm.
- Double leaf sliding door system is offered in the following sizes: 120', 140', 160', 180', 200' (for doors opening synchronously).
- Door leaves for the sliding door system are manufactured in non-rebated version in the external sizes of rebated door, e.g.: 844 x 2035 mm (80').

AVAILABILITY

- Sliding door system is available in all decors and collections apart from the following collections: Classic, Andromeda, Salvano, and Forma.
- CPL decor - Light Acacia available while stocks last.

VERTICAL CROSS-SECTION OF THE SLIDING SYSTEM

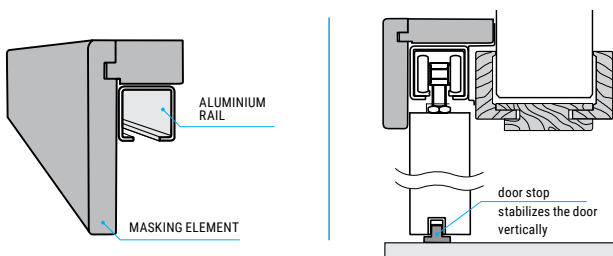



SINGLE LEAF SLIDING DOOR SYSTEM

PULL HANDLES INSTALLED IN SLIDING DOORS AS AN EXTRA-COST OPTION.

THE COLOUR OF THE PULL HANDLE ASSIGNED TO A GIVEN DECOR.

PVC ROUND PULL HANDLES



WHITE

Primo: White
3D Look: White Ash
Iridium: UNI White
CPL: RAL 9003 White, White with horizontal structur
Lacquerowane



BEIGE

Primo: Beech
3D Look: Oiled Oak, Sonoma Oak, Riviera Oak, Honey Catania, Cleveland Oak, Tocantis Oak
Iridium: Marrone Oak, Grandson Oak
CPL: Hamilton Oak, Hickory Oak



SILVER

Primo: Grey Matt
3D Look: Columbia Light Walnut, Grey Oak, Gessato Oak
Iridium: UNI Cashmere, UNI Green, UNI Graphite, UNI Black, Graphite Ash
CPL: Light Acacia, RAL 7024 Graphite, Grigio Oak, Kendal Oak, Norwegian Ash, Cashmere



BROWN

Primo: Acacia St, Walnut
CPL: Italian Walnut

STEEL FLUSH PULL HANDLES:

PRIMO, 3D LOOK, IRIDIUM, CPL, LACQUERED



BLACK



NICKEL

EXTRA-COST OPTIONS



door closer



hook lock (standard key lock, bathroom lock)

EXTRA-COST OPTIONS:

Door closer for single leaf door

Hook lock with flush pull handle, single door leaf (standard key lock, bathroom lock)

Hook lock with flush pull handle, double door leaf (standard key lock, bathroom lock)

PVC flush pull handle installed in a door leaf – white, brown, beige, silver

Steel pull handle installed in a door leaf

AERO

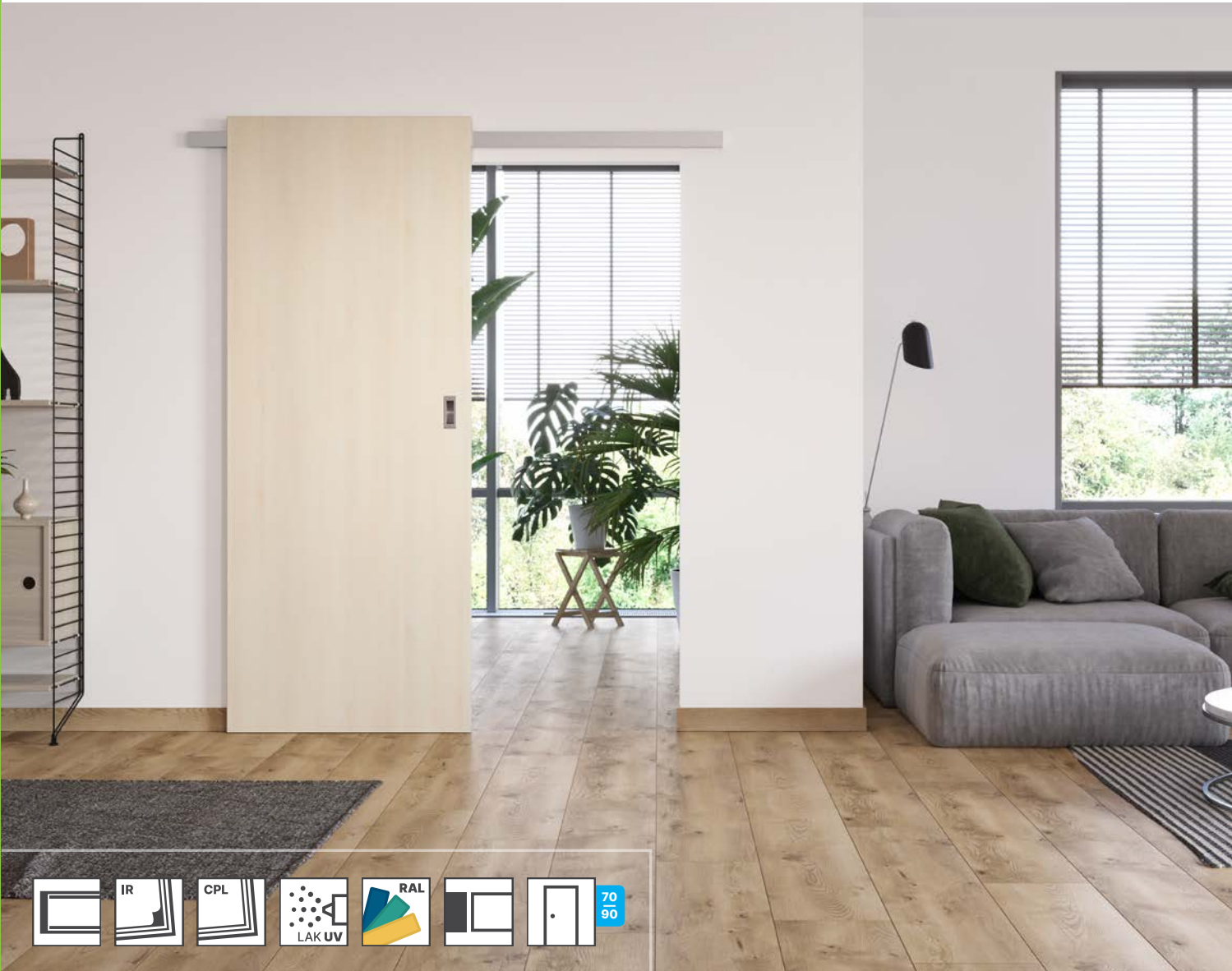

Thanks to a wide, aluminium rail, partially recessed in the door leaf, Aero System creates an aesthetic and modern combination of the door and the sliding system.

The system consists of the mechanism and the door leaf and is designed for mounting directly on the wall (no possibility of assembly with the tunnel).



DOOR LEAF WITH A RAIL - CONNECTION METHOD

DOORLEAF

- Sliding, single leaf, solid, HARD construction, equipped with stainless steel INOX pull handle as a standard. Dedicated exclusively to Aero system.
- Door leaf sizes – 744, 844, 944 x 2135 mm.

MECHANISM

- A full set consists of a 2 m aluminium rail, hardware and installation instruction.
- Available with self-closing system.
- After installing the system, the gap between the leaf and the wall is 12 mm.

EXTRA-COST OPTIONS

- RAL palette colours

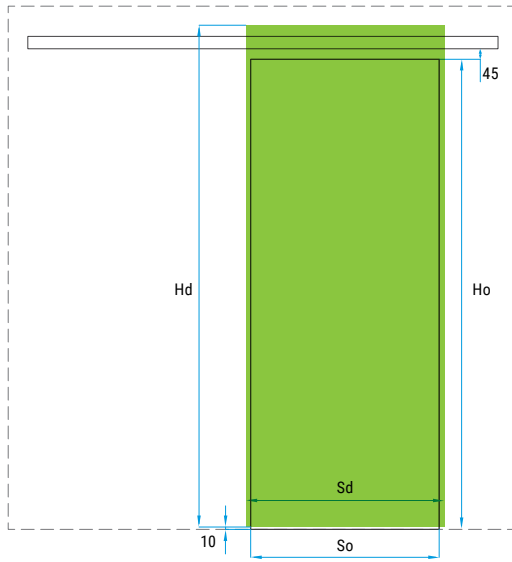

	DOOR LEAF HEIGHT H_d	WALL OPENING HEIGHT H_o	DOOR LEAF WIDTH S_d	WALL OPENING WIDTH S_o
70"	2135	2000	744	700
80"			844	800
90"			944	900

AERO SYSTEM SIZES TABLE



IRIDIUM



UNI BLACK



GRAPHITE ASH



GRANDSON OAK



HICKORY OAK

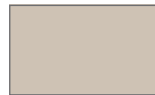

CASHMERE



HAMILTON OAK VERTICAL

CPL



HAMILTON OAK HORIZONTAL



ITALIAN WALNUT



LIGHT ACACIA



NORWEGIAN ASH



GRIGIO OAK



KENDAL OAK

CPL



WHITE WITH HORIZONTAL STRUCTUR



RAL 9003 WHITE



RAL 7024 GRAPHITE

LAKER



WHITE UV



WHITE UV PURE

MODI DESIGN



A modern sliding system perfect for loft interiors. A black steel rail and all other elements of the set give the whole a unique industrial character.

The system is designed for installation directly on the wall, available only in a single leaf version.

Door leave height: 2035 mm, available in widths 70', 80', 90' with a black recessed steel handle. Doors must be purchased separately, they are available in all collections and decors except: Classic, Andromeda, Salvano, and Forma.

Required door opening height max. 2015 mm, opening width 100 mm smaller than the leaf width. After installing the system, there is a 9 mm gap between door leaf and the wall.

PACKAGE

- Includes a complete sliding system with a 1950 mm long rail. A self-closing system is also available as an extra-cost option.



SLIDING SYSTEM WITH A STOPPER

EXTRA-COST OPTIONS

SELF-CLOSING SYSTEM



SILENT, SELF-CLOSING SYSTEM

STEEL FLUSH PULL HANDLES



STEEL BLACK

ECLISSE SLIDING POCKET DOOR SYSTEM

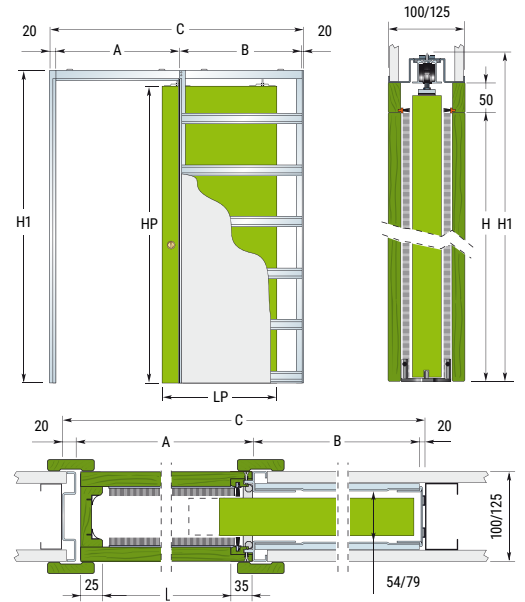

POCKET MODEL	LIGHT OPENING L X H	EXTERNAL DIMENSIONS		THICKNESS OF POCKET / WALL ¹	INTERNAL DIMENSIONS	DOOR LEAF DIMENSIONS		
		C X H1	A			B	LP	HP
G60 plus	610 x 2030	1346 x 2120	670	640	100 ²	54	644	
G70 plus	710 x 2030	1546 x 2120	770	740			744	
G80 plus	810 x 2030	1746 x 2120	870	840			844	
G90 plus	910 x 2030	1946 x 2120	970	940			944	
G100 plus ²	1010 x 2030	2146 x 2120	1070	1040			1044	
						125	79	2035

SINGLE POCKET DIMENSION TABLE

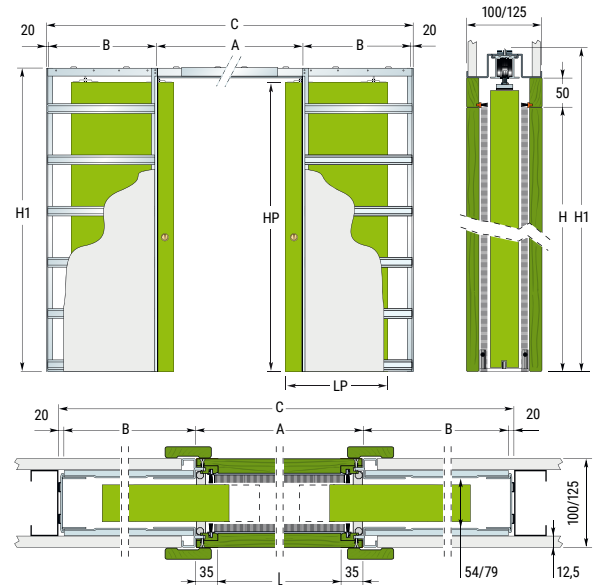

POCKET MODEL	LIGHT OPENING L X H	EXTERNAL DIMENSIONS		THICKNESS OF POCKET / WALL ¹	INTERNAL DIMENSIONS	DOOR LEAF DIMENSIONS		
		C X H1	A			B	LP	HP
GG60 plus	1220 x 2030	2600 x 2120	1290	640	100 ²	54	644	
GG70 plus	1420 x 2030	3000 x 2120	1490	740			744	
GG80 plus	1620 x 2030	3400 x 2120	1690	840			844	
GG90 plus	1820 x 2030	3800 x 2120	1890	940			944	
GG100 plus	2020 x 2030	4200 x 2120	2090	1040			1044	
						125	79	2035

DOUBLE POCKET DIMENSION TABLE

! It is not possible to install Eclisse sliding systems in combination with the following collections: Classic, Salvano, Andromeda, Forma, Demeter, Antiope.

¹ Eclisse door frames for non-standard wall thickness should be ordered in line with the order form. Door frame decors: Primo, 3D Look, Iridium and CPL.

² Pocket with a thickness of 100 mm - possibility of installing all collections except for glazed models in panel doors.

EXTRA-COST OPTIONS

Steel pull handle installed in a door leaf

PVC flush pull handle installed in a door leaf

Additional cm of adjustment range, single leaf door frame

Additional cm of adjustment range, double leaf door frame

Wood-based door frames

This group of door frames is intended for everyday use door leaves used in flats and offices. All these frames can be used with lacquered, frame and panel doors manufactured by Classen.

In this section you will find frames of a universal character, e.g. Adjustable or Standard 2-pack fixed, but also more decorative ones, such as Arcus and New Arcus. The CMOK door frame, on the other hand, is a product intended for installation on the old type of steel door frames without the need to disassemble them.





View from the inner side of the leaf.
Outer side as in the Standard 2-Pack fixed door frame.

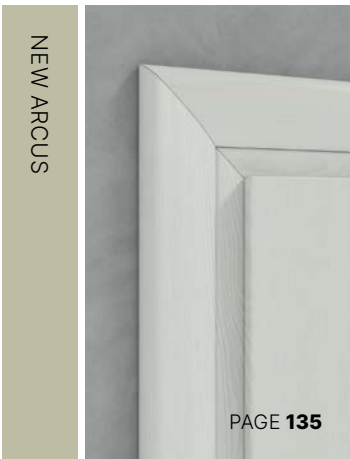

ADJUSTABLE / ADJUSTABLE 80

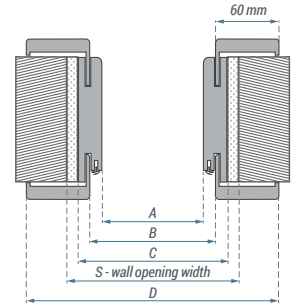
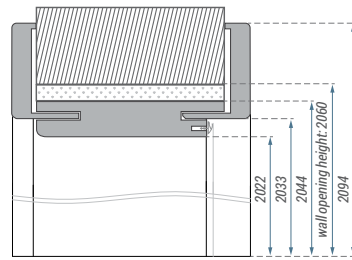
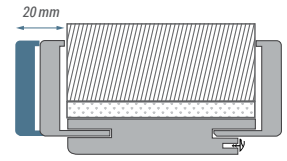
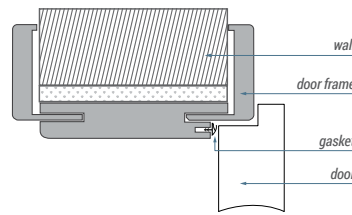

EXECUTION STANDARD

- Adjustable door frames are made of chipboard and MDF, covered with Classen decors or lacquered, in colours corresponding to door leaves colours.
- Also available in Tunnel version.

Packaging:

- Complete door frame consists of an upper beam and a base and it constitutes one package. The set includes hardware, gaskets and assembly set. For door leaves size 100' or reinforced leaves, it is required to use door frame with three hinges.

COLOURS

Primo

- Acacia ST, White, Beech, Walnut, Grey Matt ¹
- 3D Look ¹**
- Tocantis Oak, Gessato Oak, Honey Catania, Cleveland Oak, Oiled Oak, White Ash, Sonoma Oak, Columbia Light Walnut, Riviera Oak, Grey Oak

Iridium ¹

- UNI White, UNI Cashmere, UNI Green, UNI Graphite, UNI Black, Grandson Oak, Graphite Ash, Marrone Oak
- CPL**

- Hickory Oak ¹, Cashmere ¹, Hamilton Oak Vertical ¹, Light Acacia ¹, 9003 White ¹, 7024 Graphite, Italian Walnut, Norwegian Ash ¹, Kendal Oak ¹, Grigio Oak ¹, White with horizontal structur

Lacquer ¹

- PU or UV White lacquer.

▼ Dimensions of door frame for Natura HK PN22 door.

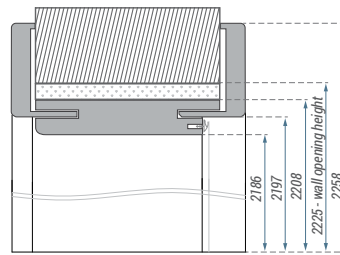

▼ Dimensions of door frame for Natura HK PN23 door.

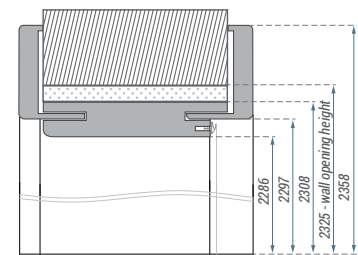

▲ ADJUSTABLE DOOR FRAME

▼ ADJUSTABLE 80 DOOR FRAME

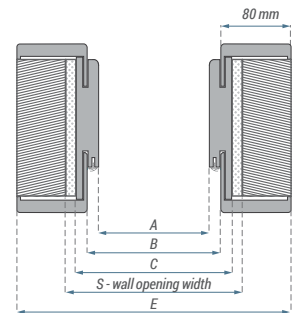
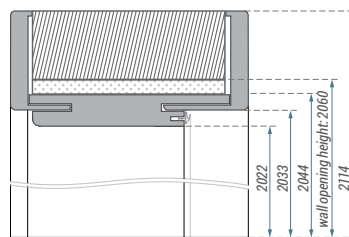

Dimensions of the adjustable door frame [mm]:

	A	B	C	D	E	S		A	B	C	D	E	S
60	603	626	648	748	788	675	100	1038	1061	1083	1183	1223	1110
70	703	726	748	848	888	775	110	1138	1161	1183	1283	1323	1210
80	803	826	848	948	988	875	120	1238	1261	1283	1383	1423	1310
90	903	926	948	1048	1088	975	130	1338	1361	1383	1483	1523	1410
100	1003	1026	1048	1148	1188	1075	140	1438	1461	1483	1583	1623	1510
110	1103	1126	1148	1248	1288	1175	150	1538	1561	1583	1683	1723	1610
120	1203	1226	1248	1348	1388	1275	160	1638	1661	1683	1783	1823	1710
170	1738	1761	1783	1883	1923	1810	170	1738	1761	1783	1883	1923	1810
180	1838	1861	1883	1983	2023	1910	180	1838	1861	1883	1983	2023	1910
190	1938	1961	1983	2083	2123	2010	190	1938	1961	1983	2083	2123	2010
200	2038	2061	2083	2183	2223	2110	200	2038	2061	2083	2183	2223	2110

Adjustment range [mm]:

75-95	220-240
95-115	240-260
120-140	260-280
140-160	280-300
160-180	300-320
180-200	320-340
200-220	340-360

SINGLE LEAF

DOUBLE LEAF

¹ Adjustable door frame 80 available in the indicated decors. Not available in heights PN22 and PN23 from the Natura HK CPL collection.

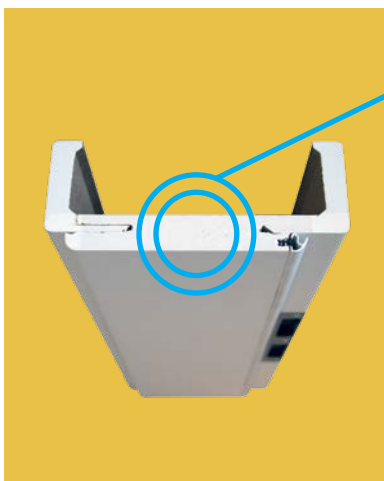

Additional Protection Hot Stamping

Protection of the bottom surface of the door frame, which is particularly prone to swelling. The protection of the door frame edges is made using "hot stamping" technology, which involves applying a protective film using high temperature and pressure. This innovative solution is offered in adjustable rebated door frames with a 60 mm band.

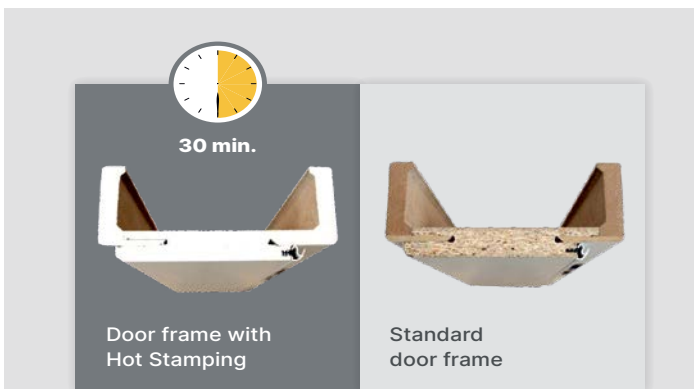

The adjustable door frame with innovative bottom edge protection, subjected to a 30-minute immersion in water, showed significantly higher resistance to absorption compared to the version without protection.

EXTRA-COST OPTIONS:

Size 100'

Size 110'

Size 120'

PN 22 adjustable door frame height

PN 23 adjustable door frame height

Double leaf door frame

80 mm band for adjustable door frame

Third hinge

Door frame in tunnel version

RAL colours

NON-REBATED ADJUSTABLE / ADJUSTABLE 80



EXECUTION STANDARD

- Adjustable non-rebated door frames are made of chipboard and MDF, covered with Classen decors or lacquered, in colours corresponding to door leaves colours. Door frames are designed to be used with non-rebated door leaves.

Packaging:

- Complete non-rebated door frame consists of an upper beam and a base and it constitutes one package. The set includes two non-rebated hidden hinges, gaskets and an assembly set.

COLOURS

Primo

- Grey Matt ¹
3D Look
- Tocantis Oak ¹
Iridium ¹
- UNI White, UNI Cashmere, UNI Green, UNI Grafit, UNI Black, Grandson Oak, Graphite Ash, Marrone Oak **CPL**
- Hickory Oak ¹, Cashmere ¹, Hamilton Oak Vertical ¹, Light Acacia ¹, 9003 White ¹, 7024 Graphite, Italian Walnut, Norwegian Ash ¹, Kendal Oak ¹, Grigio Oak ¹, White with horizontal structure **Lacquer ¹**
- PU or UV White lacquer.

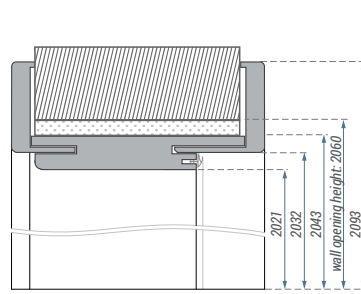

▼ Dimensions of door frame for Natura HB PN22 door.

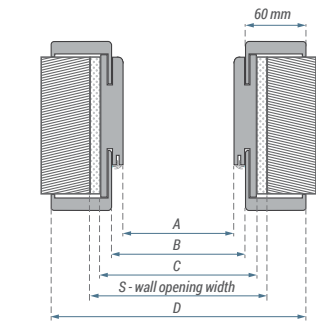
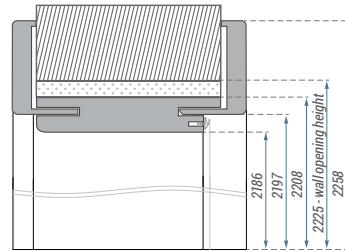

▼ Dimensions of door frame for Natura HB PN23 door.

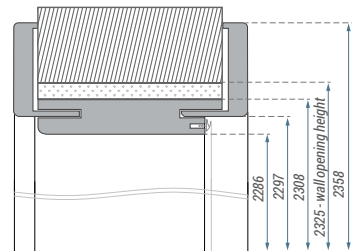

▲ ADJUSTABLE DOOR FRAME NON-REBATED

▼ ADJUSTABLE DOOR FRAME NON-REBATED 80

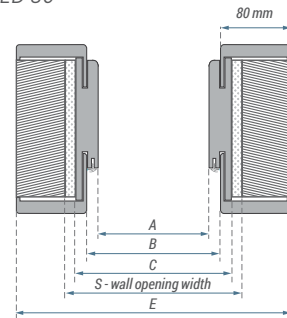
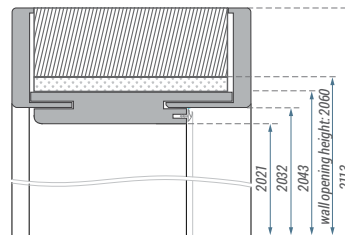

Dimensions of the adjustable non-rebated door frame [mm]:

	A	B	C	D	E	S
60	601	624	646	746	786	690
70	701	724	746	846	886	790
80	801	824	846	946	986	890
90	901	924	946	1046	1086	990
100	1001	1024	1046	1146	1186	1090

Adjustment range [mm]:

90-110	235-255
110-130	255-275
135-155	275-295
155-175	295-315
175-195	315-335
195-215	335-355
215-235	355-375

¹ | Adjustable B 80 door frame available in marked decors. Not available in Natura HB CPL - PN22 and PN23 models.

EXTRA-COST OPTIONS:

- Size 100'
- Size 110'
- Size 120'
- PN 22 adjustable door frame height
- PN 23 adjustable door frame height
- Third hinge
- RAL colours

ADJUSTABLE REVERSE 80

NEW!

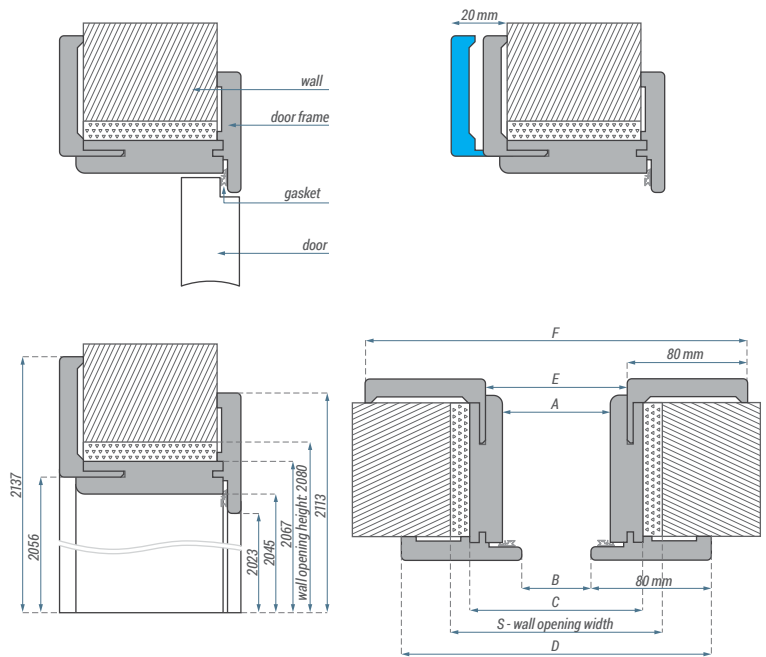

EXECUTION STANDARD

- Adjustable reverse door frames are made of chipboard and MDF, covered with selected Classen decors or lacquered, in colours corresponding to door leaves colours. This door frame is designed to be used with reverse door leaves, i.e. with reverse rebate. Doors with reverse rebate are flush with the frame in the same way as non-rebate doors, but allow them to be opened in the opposite direction, inwards to the door frame. This solution, most often used in combination with non-rebated doors, allows to achieve the effect of all doors being flush, for example, as seen from the hall and opening inwards into the room.

Packaging:

- Complete reverse door frame consists of an upper beam and a base and it constitutes one package. The set includes two reverse concealed hinges, gaskets and assembly set.

COLOURS

Primo

- Grey Matt

3D Look

- Tocantis Oak, Riviera Oak

Iridium

- UNI White, UNI Cashmere, UNI Black, Marrone Oak, Grandson Oak, Graphite Ash

CPL

- 9003 White, Italian Walnut, Norwegian Ash, Kendal Oak, Grigio Oak, White with horizontal structur

Lacquer

- PU or UV White lacquer.

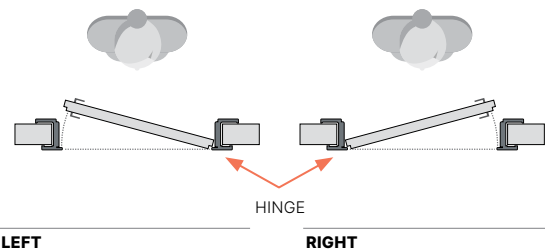

Dimensions of reverse door frame [mm]:

	A	B	C	D	E	F	S
60	650	624	694	786	673	835	720
70	750	724	794	886	773	935	820
80	850	824	894	986	873	1035	920
90	950	924	994	1086	973	1135	1020
100	1050	1024	1094	1186	1073	1235	1120

SINGLE LEAF

Adjustment range [mm]:

90-110	235-255
110-130	255-275
135-155	275-295
155-175	295-315
175-195	315-335
195-215	335-355
215-235	355-375

EXTRA-COST OPTIONS:

Size 100'

Third hinge

RAL colours

ARCUS



EXECUTION STANDARD

- Arcus door frames are made of MDF, covered with Primo, 3D Look and Iridium veneer and Classen CPL laminate in decors corresponding to door leaves decors. Base elements have been integrated on one side with finishing mouldings.
- Also available in Tunnel version.

Packaging:

- Complete door frame consists of upper beam and base element (two separate packages), which is equipped with two silver pintle hinges (the third hinge - as an extra-cost option). For door leaves size 100' or reinforced leaves, it is required to use door frame with three hinges.

COLOURS

Primo

- Acacia St, White, Walnut

3D Look

- White Ash, Colombia Light Walnut, Grey Oak, Gessanto Oak

Iridium

- Graphite Ash

CPL

- Light Acacia ¹, Italian Walnut, Grigio Oak, Norwegian Ash, White with horizontal structur

¹ | Decor is available while stocks last.

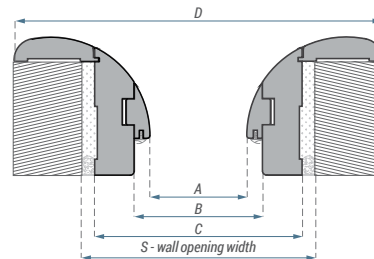
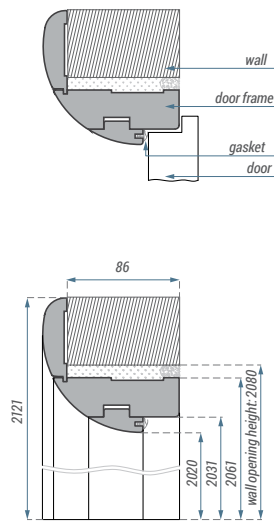

Dimensions of Arcus door frame [mm]:

	A	B	C	D	S		A	B	C	D	S
60	602	626	686	806	710	100	1037	1061	1121	1241	1145
70	702	726	786	906	810	110	1137	1161	1221	1341	1245
80	802	826	886	1006	910	120	1237	1261	1321	1441	1345
90	902	926	986	1106	1010	130	1337	1361	1421	1541	1445
100	1002	1026	1086	1206	1110	140	1437	1461	1521	1641	1545
SINGLE LEAF						150	1537	1561	1621	1741	1645
						160	1637	1661	1721	1841	1745
						170	1737	1761	1821	1941	1845
						180	1837	1861	1921	2041	1945
						190	1937	1961	2021	2141	2045
						200	2037	2061	2121	2241	2145

DOUBLE LEAF

EXTRA-COST OPTIONS:

Size 100'

Double leaf door frame

NEW ARCUS

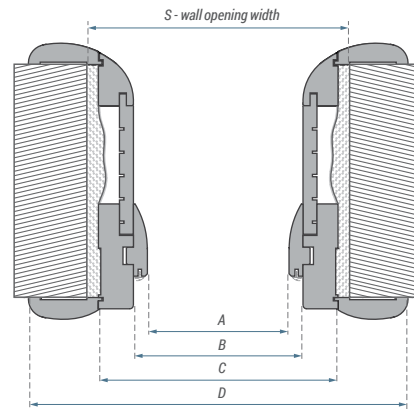
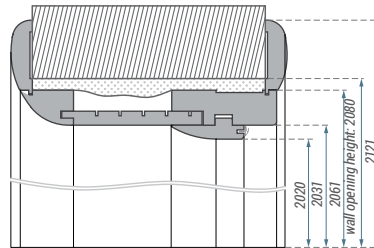
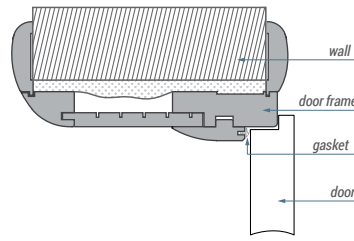

EXECUTION STANDARD

- New Arcus door frames are made of MDF, covered with Primo, 3D Look and Iridium veneer and Classen CPL laminate in decors corresponding to door leaves decors. Besides modern design, the advantage of this door frame is its universal application - for the purpose of adjustment to different wall thickness, this door frame is available in two adjustment ranges: 115-200 mm and 200-320 mm.
- Also available in Tunnel version.

Packaging:

- Complete door frame consists of upper beam and base element (two separate packages), which is equipped with two silver pintle hinges (the third hinge - as an extra-cost option). For door leaves size 100' or reinforced leaves, it is required to use door frame with three hinges.

COLOURS

Primo

- White, Acacia ST, Walnut

3D Look

- White Ash, Colombia Light Walnut, Grey Oak

Iridium

- Graphite Ash, Marrone Oak

CPL

- Light Acacia ¹, Italian Walnut, Norwegian Ash, Kendal Oak, Grigio Oak, White with horizontal structur

¹ | Decor is available while stocks last.

Dimensions of New Arcus door frame [mm]:

	A	B	C	D	S		A	B	C	D	S
60	602	626	686	806	710	100	1037	1061	1121	1241	1145
70	702	726	786	906	810	110	1137	1161	1221	1341	1245
80	802	826	886	1006	910	120	1237	1261	1321	1441	1345
90	902	926	986	1106	1010	130	1337	1361	1421	1541	1445
100	1002	1026	1086	1206	1110	140	1437	1461	1521	1641	1545
SINGLE LEAF						150	1537	1561	1621	1741	1645
						160	1637	1661	1721	1841	1745
						170	1737	1761	1821	1941	1845
						180	1837	1861	1921	2041	1945
						190	1937	1961	2021	2141	2045
						200	2037	2061	2121	2241	2145
						DOUBLE LEAF					

EXTRA-COST OPTIONS:

Size 100'

Double leaf door frame

STANDARD 2-PACK FIXED

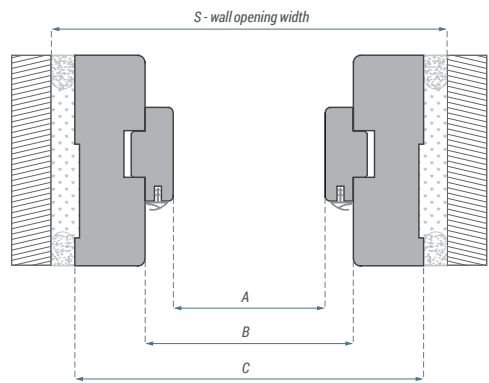
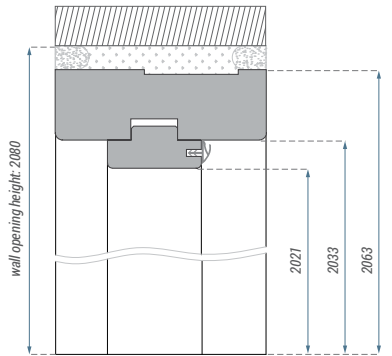
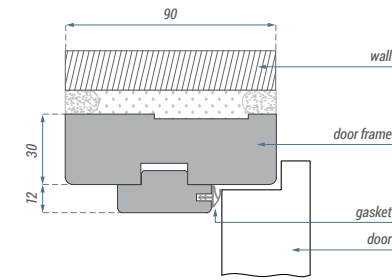

EXECUTION STANDARD

- Standard 2-pack fixed door frames are made of MDF, covered with Primo, 3D Look and Iridium veneer and CPL laminate in decors corresponding to door leaves decors.

Packaging:

- Complete door frame consists of upper beam and base element (two separate packages), which is equipped with two silver pintle hinges (the third hinge - as an extra-cost option). For door leaves size 100' or reinforced leaves, it is required to use door frame with three hinges.

COLOURS

Primo

- Acacia ST, White, Beech, Walnut, Grey Matt

3D Look

- Tocantis Oak, Gessato Oak, Honey Catania, Cleveland Oak, Oiled Oak, White Ash, Sonoma Oak, Columbia Light Walnut, Riviera Oak, Grey Oak

Iridium

- Grandson Oak, Graphite Ash, UNI White, UNI Cashmere, UNI Green, UNI Grafit, UNI Black, Marrone Oak

CPL

- Light Acacia, Italian Walnut, 9003 White, 7024 Graphite, Norwegian Ash, Kendal Oak, Grigio Oak, White with horizontal structur

Lacquer

- PU or UV White

Dimensions of Std 2-pack door frame [mm]:

	A	B	C	S		A	B	C	S
60	602	626	686	710	100	1037	1061	1121	1145
70	702	726	786	810	110	1137	1161	1221	1245
80	802	826	886	910	120	1237	1261	1321	1345
90	902	926	986	1010	130	1337	1361	1421	1445
100	1002	1026	1086	1110	140	1437	1461	1521	1545
110	1102	1126	1186	1210	150	1537	1561	1621	1645
120	1202	1226	1286	1310	160	1637	1661	1721	1745
SINGLE LEAF					170	1737	1761	1821	1845
					180	1837	1861	1921	1945
					190	1937	1961	2021	2045
					200	2037	2061	2121	2145

DOUBLE LEAF

EXTRA-COST OPTIONS:

Size 100'

Size 110'

Size 120'

Double leaf door frame

Metal sheet for an electric strike in technical doors

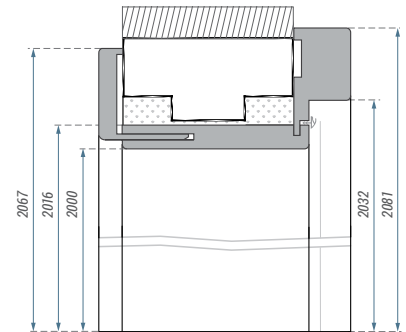
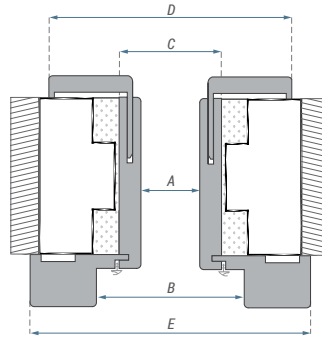
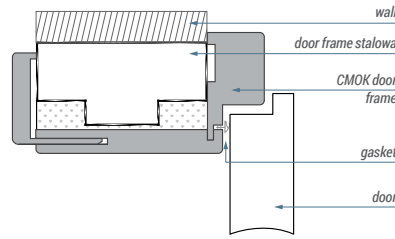

EXECUTION STANDARD

- Adjustable single door leaf frame, designed to be installed on a steel door frame, without the need to dismantle it beforehand. It allows the exchange of door leaves while maintaining their current dimensions. A distinctive feature of this door frame is a quick and easy installation possible owing to permanent fixture of two base elements. The door frame is entirely made of wood-based material - MDF, covered with Primo, 3D and Iridium decors and CPL laminates.

Packaging:

- A complete door frame is available in two adjustment ranges: 70-110 mm and 110-150 mm. Both ranges are available in a single package, which also contains a gasket and assembly bag. For door leaves size 100' and reinforced door leaves it is required to use a door frame with three hinges.

COLOURS

Primo

- Acacia ST, Beech, Walnut, White

3D Look

- Tocantis Oak, Sonoma Oak, White Ash, Oiled Oak, Colombia Light Walnut, Riviera Oak, Grey Oak

Iridium

- Grandson Oak, Graphite Ash, UNI White, UNI Cashmere, UNI Green, UNI Gracit, UNI Black, Marrone Oak

CPL

- Italian Walnut, Light Acacia, Norwegian Ash, Kendal Oak, Grigio Oak

Installation - remarks:



1. Curvature of walls, on which CMOK door frame will be installed.

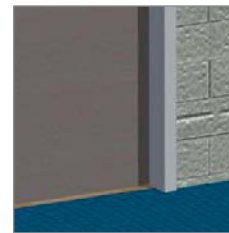

2. Floors connection point and change in the door leaf position after installing CMOK door frame.

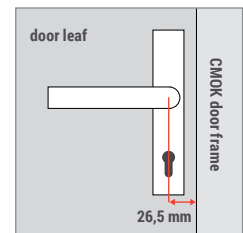

3. Handle and rosette dimensions. Door handle cannot extend beyond the spindle.

Adjustment insert

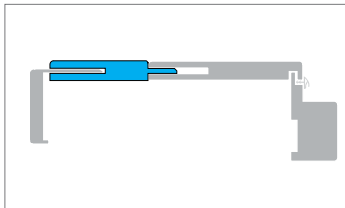

Dimensions of CMOK door frame [mm]:

	A	B	C	D	E
60	561	626	593	696	723
70	661	726	693	796	823
80	761	826	793	896	923
90	861	926	893	996	1023
100	961	1026	993	1096	1123
110	1061	1126	1093	1196	1223

	A	B	C	D	E	F
60	574	593	561	723	626	696
70	674	693	661	823	726	796
80	774	793	761	923	826	896
90	874	893	861	1023	926	996
100	974	993	961	1123	1026	1096
110	1074	1093	1061	1223	1126	1196

EXTRA-COST OPTIONS:

Size 100'

Size 110'

75MM ADJUSTMENT INSERT INCREASES THE ADJUSTMENT RANGE
 • IN THE 70-110 MM DOOR FRAME TO 150-185 MM
 • IN THE 110-150 MM DOOR FRAME TO 185-220 MM

Steel door frames

Steel door frames are perfect for flats and offices, but all their advantages are revealed in public utility buildings and rooms with heavy traffic. All steel door frames can be used in combination with Natura HK/HB (CPL and HPL) technical doors as well as standard lacquered frame and panel doors manufactured by Classen.

On the following pages you will find adjustable and fixed door frames, each of which is offered in rebated and non-rebated versions.

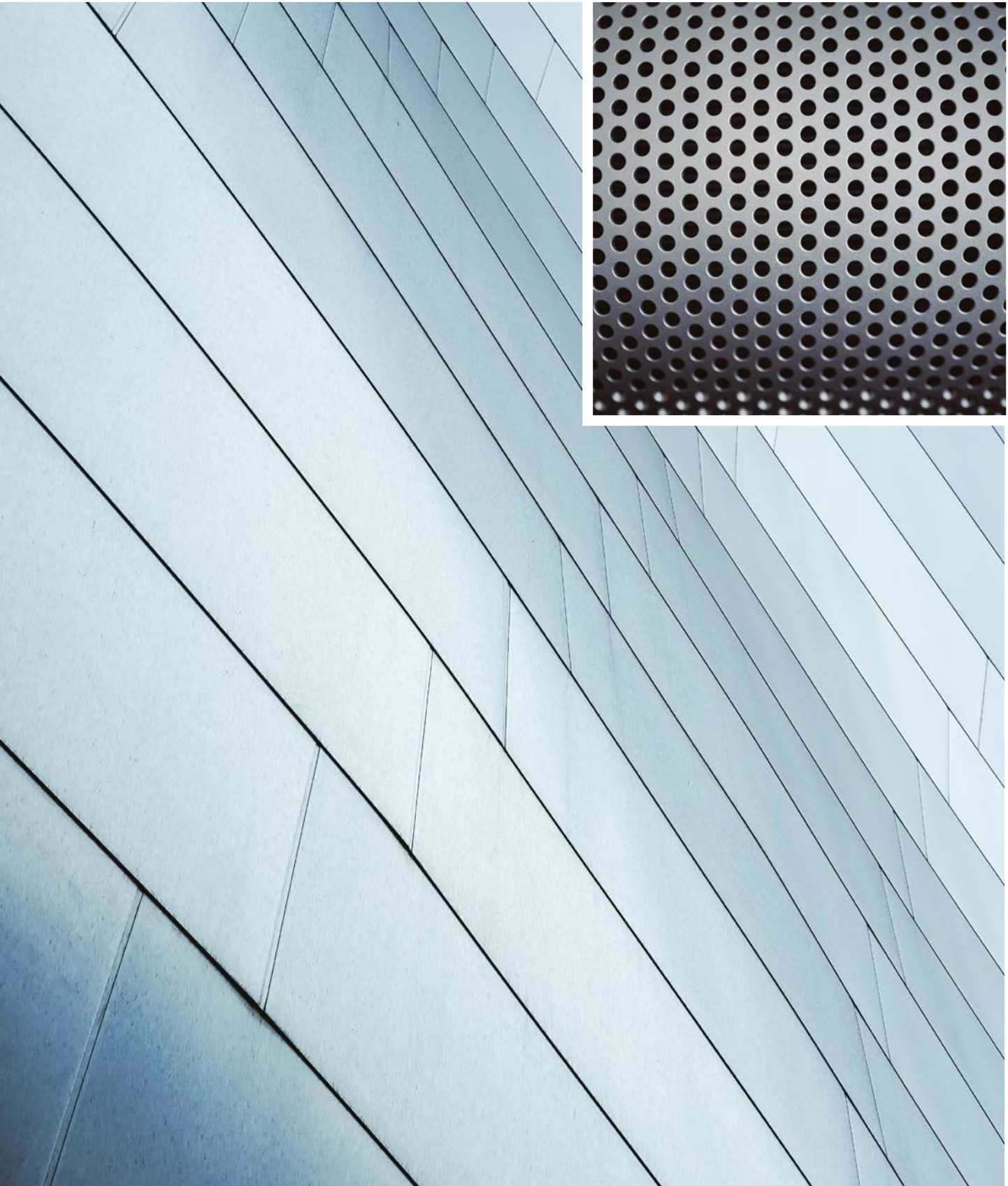

STEEL FIXED REBATED / NON-REBATED



EXECUTION STANDARD

- made of high-quality steel plate, thickness 1.2 mm
- the full door frame consists of one base element, hinges, gasket and full set of cover caps
- gaskets available in three colours - White, Grey, Brown
- two hidden hinges 3D as standard (non-rebated version)
- two hinges as standard; third hinge as non-extra-cost option (rebated version)
- door frame designed for installation in rooms with completed walls and floor
- non-rebated door frame available only in a single leaf version
- door frame marking: rebated version FD12, non-rebated version FD93

COLOURS

- powder coated door frame. RAL colours: White (9003), Grey (7047), Graphite (7024)
- other RAL colours as well as other custom features are subject to individual pricing: inwestycje@classen.com.pl

Dimensions of fixed steel and fixed steel non-rebated door frame (single leaf) [mm]:

	A	B	C	D	S
60	601	627	671	697	685
70	701	727	771	797	785
80	801	827	871	897	885
90	901	927	971	997	985
100	1001	1027	1071	1097	1085
110	1101	1127	1171	1197	1185
120	1201	1227	1271	1297	1285

SINGLE LEAF

	A	B	C	D	S
120	1235	1261	1305	1331	1315
130	1335	1361	1405	1431	1415
140	1435	1461	1505	1531	1515
150	1535	1561	1605	1631	1615
160	1635	1661	1705	1731	1715
170	1735	1761	1805	1831	1815
180	1835	1861	1905	1931	1915
190	1935	1961	2005	2031	2015
200	2035	2061	2105	2131	2115

DOUBLE LEAF

STEEL FIXED REBATED ▼

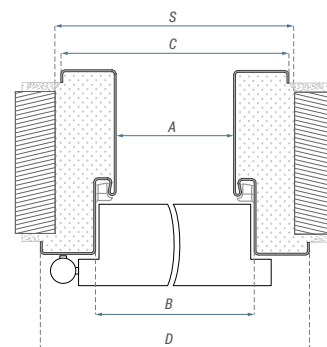
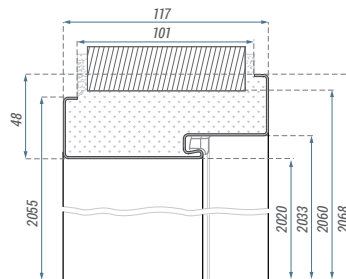
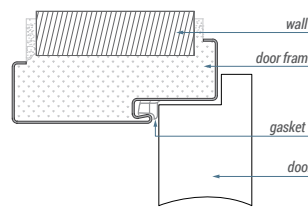

STEEL FIXED NON-REBATED ▼

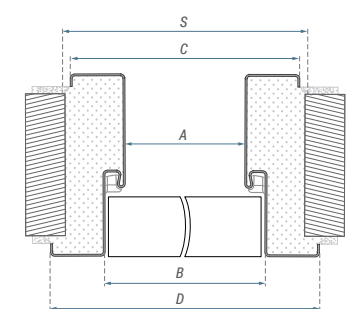
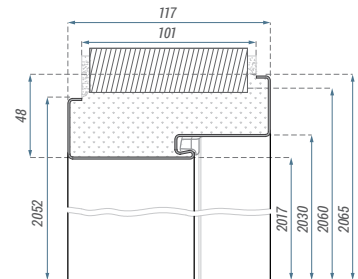
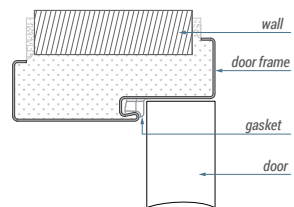

EXTRA-COST OPTIONS:

Double leaf door frames

RAL 7024, 1015, 8014 steel door frame

Execution in galvanized steel

Reinforcement for door closer

Preparation for electric strike

Non-standard heights

STEEL ADJUSTABLE

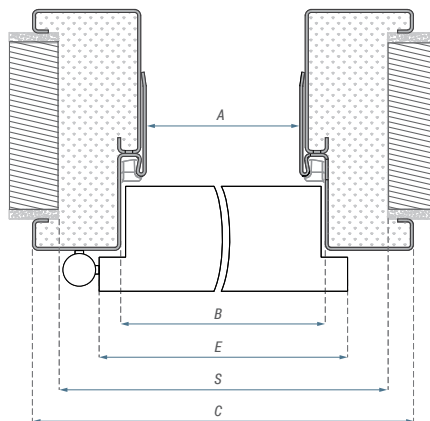
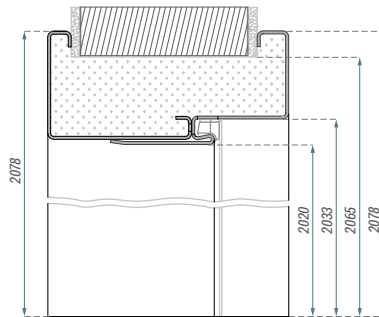
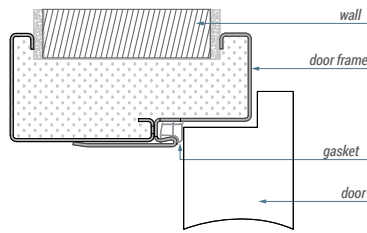

EXECUTION STANDARD

- Steel adjustable door frames are designed for installation in different types of rooms with completed walls and floor - flats, public utility building, hotels, etc.
- Durable construction enables application both in masonry walls as well as drywalls.
- door frame marking: FD61-FD69

Construction:

- made of high-quality steel plate, thickness 1.5 mm;
- a full door frame consists of a base element, adjusting part, hinges, gasket and full set of cover caps;
- gaskets available in three colours - White, Grey, Brown;
- two hinges as standard; third hinge as a non-extra-cost option.

COLOURS

- Powder coated door frame. RAL colours: White (9003), Grey (7047), Graphite (7024).
- Other RAL colours as well as other custom features are subject to individual pricing: inwestycje@classen.com.pl

Dimensions of the adjustable steel door frame [mm]:

	A	B	C	E	S
60	601	627	717	644	685
70	701	727	817	744	785
80	801	827	917	844	885
90	901	927	1017	944	985
100	1001	1027	1117	1044	1085
110	1101	1127	1217	1144	1185
120	1201	1227	1317	1244	1285

Adjustment range [mm]:

95-125	245-275
125-155	275-305
155-185	305-335
185-215	335-365
215-245	

SINGLE LEAF

	A	B	C	E	S
100	1035	1061	1151	1079	1120
110	1135	1161	1251	1179	1220
120	1235	1261	1351	1279	1320
130	1335	1361	1451	1379	1420
140	1435	1461	1551	1479	1520
150	1535	1561	1651	1579	1620
160	1635	1661	1751	1679	1720
170	1735	1761	1851	1779	1820
180	1835	1861	1951	1879	1920
190	1935	1961	2051	1979	2020
200	2035	2061	2151	2079	2120

DOUBLE LEAF

EXTRA-COST OPTIONS:

Double leaf door frames

RAL 7024, 1015, 8014 steel door frame

Execution in galvanized steel

Reinforcement for door closer

Preparation for electric strike

STEEL ADJUSTABLE NON-REBATED

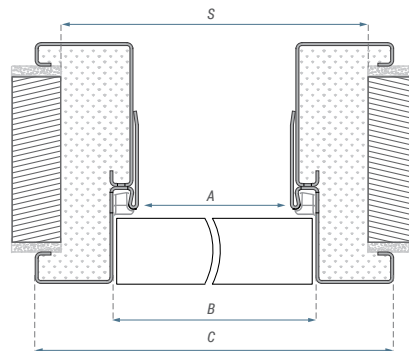
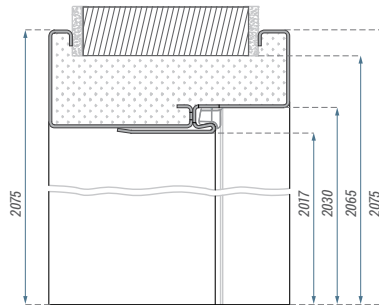
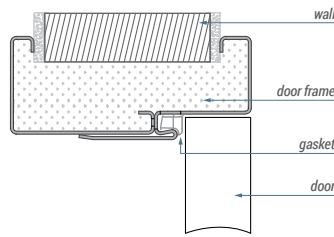

EXECUTION STANDARD

- made of high-quality steel plate, thickness 1.5 mm
- a full door frame consists of a base element, adjusting part, hinges, gasket and full set of cover caps
- gaskets available in three colours - White, Grey, Brown
- two hidden hinges 3D as standard
- door frame designed for installation in rooms with completed walls and floor
- available only in single leaf version
- door frame marking: FD71-FD79

COLOURS

- powder coated door frame. RAL colours: White (9003), Grey (7047), Graphite (7024)
- other RAL colours as well as other custom features are subject to individual pricing: investycje@classen.com.pl

Dimensions of the adjustable non-rebated steel door frame [mm]:

	A	B	C	S
60	601	627	717	695
70	701	727	817	795
80	801	827	917	895
90	901	927	1017	995
100	1001	1027	1117	1095
110	1101	1127	1217	1195
120	1201	1227	1317	1295

Adjustment range [mm]:

110-140	260-290
140-170	290-320
170-200	320-350
200-230	350-380
230-260	

EXTRA-COST OPTIONS:

Double leaf door frames

RAL 7024, 1015, 8014 steel door frame

Execution in galvanized steel

Reinforcement for door closer

Recommended door frames

Specialized technical doors require appropriately selected door frames. For example, fire doors do not meet their standards and are ineffective without a matching door frame with fire-resistant properties.

In this section you will find frames matching Classen technical doors, such as Bord, Bord W3, acoustic and fire doors.



BORD STEEL FIXED / CORNER FIXED



EXECUTION STANDARD

- steel plate thickness 1.2 mm
- openings for top and bottom deadbolt lock (B - for Bord steel fixed door frame and Bord steel fixed corner door frame) or multipoint lock openings (W - only for Bord steel fixed door frame)
- openings for interlocking door bolts for W1 (for Bord steel fixed door frame and Bord steel fixed corner door frame) and W2 (only for Bord steel fixed door frame) door leaf versions.
- reinforcement for door closer
- single leaf 80'-100'
- door frame marking: fixed FD12, corner fixed FD14

COLOURS

- powder coated door frame. RAL colours: White (9016), Grey (7047), Brown (8017), White (9003), Graphite (7024)
- other RAL colours as well as other custom features are subject to individual pricing: inwestycje@classen.com.pl

Dimensions of BORD fixed door frame [mm]:

	A	B	C	D	E	S
80	801	827	871	897	844	875
90	901	927	971	997	944	975
100	1001	1027	1071	1097	1044	1075

Dimensions of BORD corner fixed door frame [mm]:

	A	B	C	D	E	S
80	801	827	829	897	844	865
90	901	927	929	997	944	965
100	1001	1027	1029	1097	1044	1065

BORD STEEL FIXED ▼

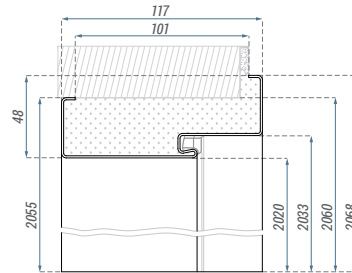
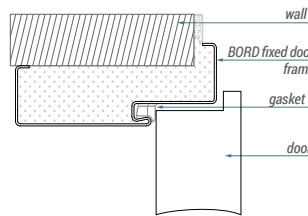

BORD STEEL CORNER FIXED ▼

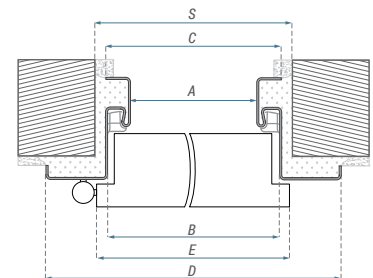
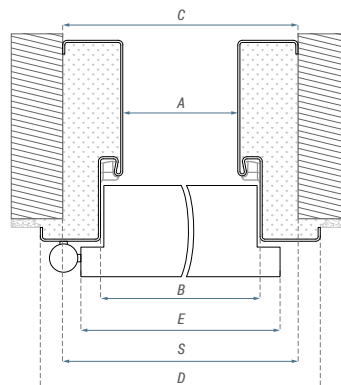
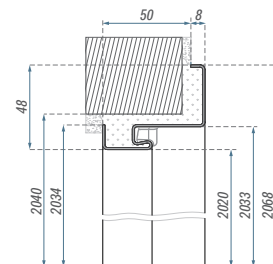
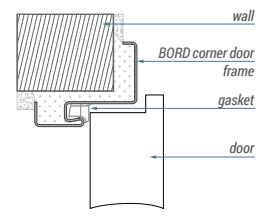

EXTRA-COST OPTIONS:

Size 100'

RAL 7024 steel door frame

Stainless steel threshold (size 80', 90')

BORD MDF FIXED



EXECUTION STANDARD

- This door frame is designed for internal entrance door leaves. It is made of MDF board, veneered with Classen decors.
- surface finishing: Primo, Iridium, 3D Look, CPL
- bolt lock striking plate top and bottom (B) or multipoint lock striking plate (W)
- version W2 includes sleeves for interlocking door bolts
- single leaf 80'-100'
- adjustment set and ranges on page 151

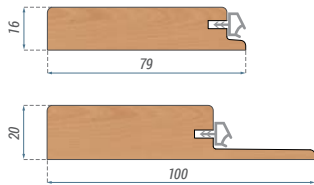

Fixed, wooden threshold with a gasket.
100 cm long threshold - for shortening by the buyer. Hardwood, protected by clear lacquer.

BORD MDF FIXED ▼

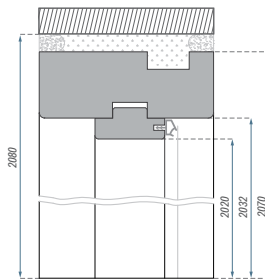

BORD ADJUSTABLE MDF ▼

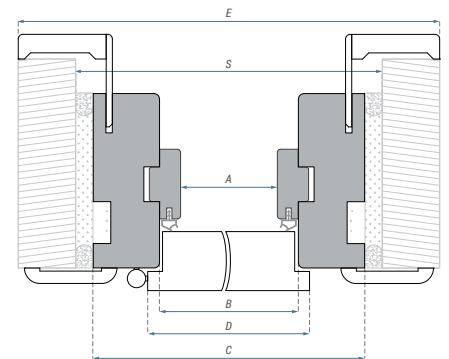
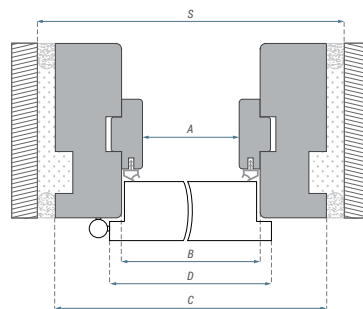
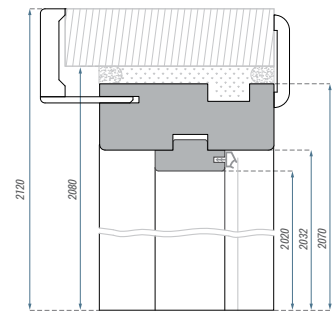

Dimensions of BORD MDF door frame [mm]:

	A	B	C	D	E	S
80	802	826	902	844	1002	925
90	902	926	1002	944	1102	1025
100	1002	1026	1102	1044	1202	1125

EXTRA-COST OPTIONS:

Size 100'

Wooden threshold, 100 cm long, size 20 x 100 mm / 16 x 79 mm

HYBRYDA



EXECUTION STANDARD

- Hybryda door frame is designed for BORD B, W and W3 internal entrance door leaves. A complete door frame consists of Hybryda steel door frame and an adjustment element.
- When installed, they create one whole. Depending on the direction of opening the door, the adjustment element may relate to the colour of the joinery inside the flat or be a decoration of the staircase.

Packaging:

- Hybryda door frame and adjustment element are packed in two separate packages.

ADJUSTMENT ELEMENT COLOURS

3D Look

- Tocantis Oak, Sonoma Oak, White Ash, Oiled Oak, Colombia Light Walnut, Riviera Oak, Grey Oak, Honey Catania, Gessato Oak, Cleveland Oak

Iridium

- Graphite Ash, Marrone Oak, Grandson Oak, UNI Cashmere

CPL

- Light Acacia, Norwegian Ash, Italian Walnut, White (RAL 9003), Graphite (RAL 7024), Grigio Oak, Kendal Oak

COLOURS OF THE STEEL ELEMENT

Powder coated

- RAL colours: White (9003), Grey (7047), Graphite (7024)

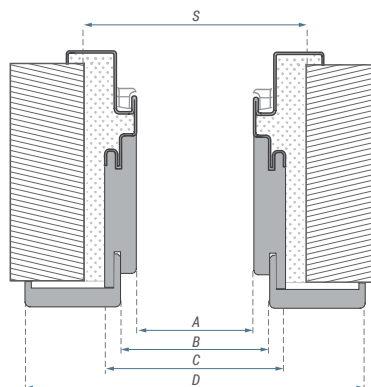
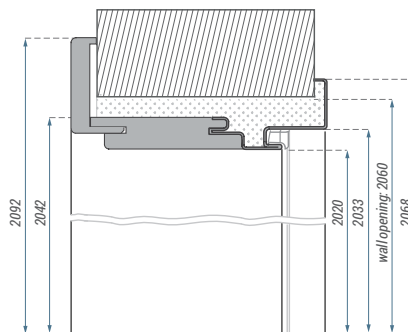
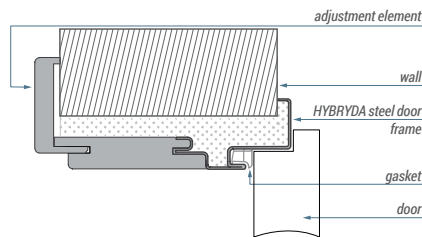

Dimensions of Hybryda door frame [mm]:

	A	B	C	D	S
80	804	826	848	949	875
90	904	926	948	1049	975
100	1004	1026	1048	1149	1075

Adjustment range [mm]:

140-180	220-260
180-220	260-300

EXTRA-COST OPTIONS:

RAL 7024 steel door frame

Size 100'

Stainless steel threshold (size 80', 90')

BORD W3 STEEL FIXED



EXECUTION STANDARD

- steel plate thickness 1.5 mm;
- complete door frame includes gasket, 3 hinges and full set of cover caps
- gaskets available in three colours - White, Grey, Brown
- openings for multipoint lock (W)
- openings for interlocking door bolts
- reinforcement for door closer
- single leaf 80'-100'
- door frame marking: FD12

COLOURS

- powder coated door frame. RAL colours: Grey (7047), White (9003), Graphite (7024)
- other RAL colours as well as other custom features are subject to individual pricing: inwestycje@classen.com.pl

Dimensions of BORD W3 fixed door frame [mm]:

	A	B	C	D	E	S
80	801	827	871	897	844	885
90	901	927	971	997	944	985
100	1001	1027	1071	1097	1044	1085

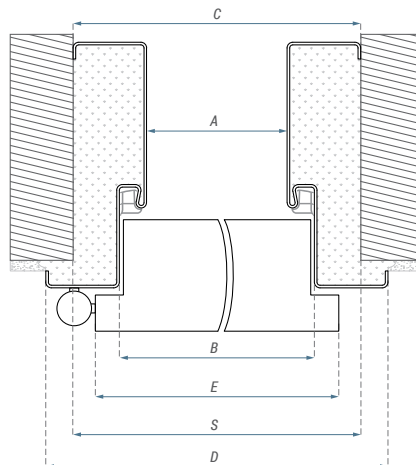
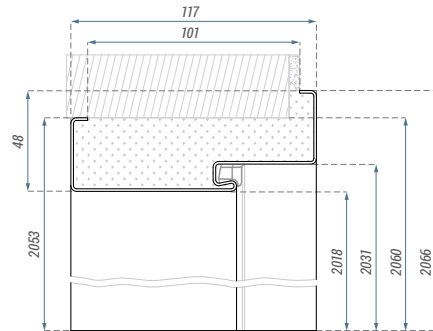
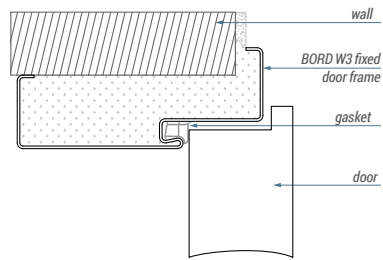

GUARD STEEL FIXED / ADJUSTABLE



EXECUTION STANDARD

- made of high quality steel plate, thickness 1.5 mm
- complete door frame includes gasket, hinges and full set of cover caps
- gaskets available in three colours: White, Grey, Brown
- 3 silver three-wing hinges constitute a complete set (door + door frame)
- door frame marking: fixed FD12, adjustable (depending on the adjustment range) FD61-FD69

COLOURS

- powder coated door frame. RAL colours: White (9003), Grey (7047), Graphite (7024)
- other RAL colours as well as other custom features are subject to individual pricing: inwestycje@classen.com.pl

Dimensions of GUARD fixed door frame [mm]:

	A	B	C	D	S
70	701	727	771	797	785
80	801	827	871	897	885
90	901	927	971	997	985
100	1001	1027	1071	1097	1085
110	1101	1127	1171	1197	1185

Dimensions of GUARD adjustable door frame [mm]:

	A	B	C	S
70	701	727	817	785
80	801	827	917	885
90	901	927	1017	985
100	1001	1027	1117	1085
110	1101	1127	1217	1185

GUARD adjustable door frame adjustment ranges [mm]:

95-125
125-155
155-185
185-215
215-245
245-275
275-305
305-335
335-365

GUARD STEEL FIXED ▼

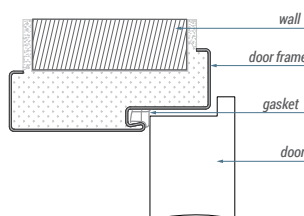

GUARD STEEL ADJUSTABLE ▼

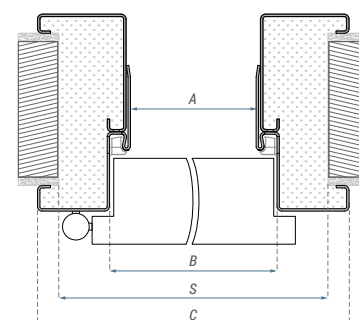
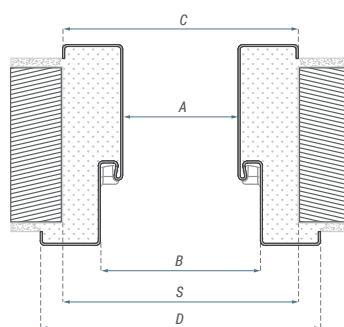
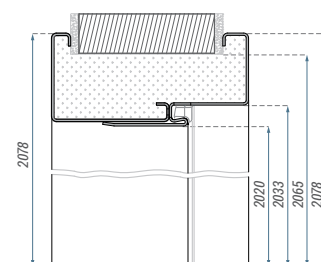
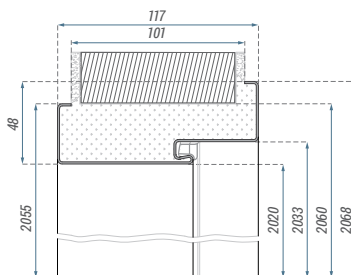
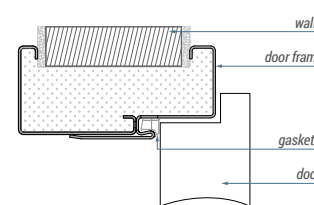

FIRE WOODEN FIXED / ADJUSTABLE



EXECUTION STANDARD – FIRE WOODEN

- FIRE wooden fixed door frame 100 mm is made of wood, veneered with Iridium decors and CPL laminates, as for FIRE door
- a complete door frame includes four adjustable 3D hinges and a gasket
- EI30 W1/W2 version does not include expanding seals
- EI60 W1/W2 version includes expanding seal
- available sizes – 80', 90', 91', 100', 101', 110', 120'
- double leaf door frames and other custom features are subject to individual pricing: inwestycje@classen.com.pl
- adjustment set and ranges on page 151

COLOURS

3D Look

- Tocantis Oak, Riviera Oak

Iridium

- UNI Cashmere, UNI Black, Grandson Oak, Graphite Ash, Marrone Oak

CPL

- Light Acacia ¹, 9003 White, 7024 Graphite, Italian Walnut, Norwegian Ash, Kendal Oak, Grigio Oak, White with horizontal structur.

Lacquer

- PU or UV White lacquer.

¹ | Decor is available while stocks last.

FIRE WOODEN FIXED ▼

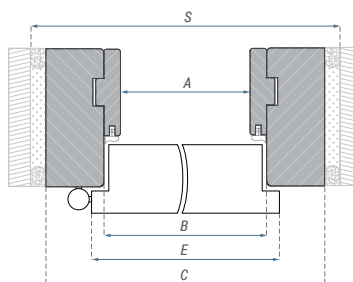
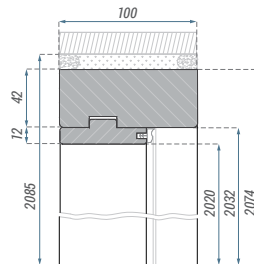
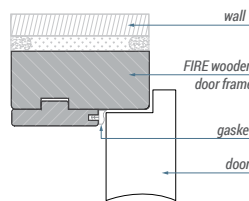

FIRE WOODEN ADJUSTABLE ▼

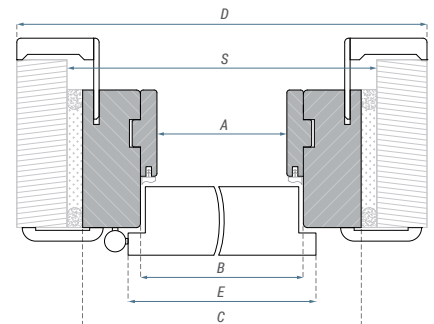
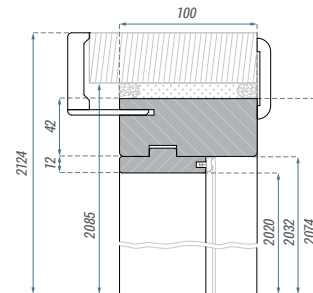
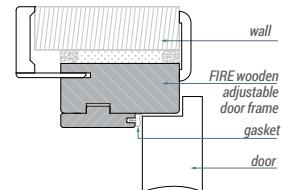

Dimensions of FIRE wooden fixed and adjustable door frame [mm]:

	A	B	C	D	E	S		
SINGLE LEAF	80	802	826	910	1010	844	930	
	90	902	926	1010	1110	944	1030	
	91	914	938	1022	1122	956	1042	
	100	1002	1026	1110	1210	1044	1130	
	101	1014	1038	1122	1222	1056	1142	
	110	1102	1126	1210	1310	1144	1230	
	120	1202	1226	1310	1410	1244	1330	
	DOUBLE LEAF	120	1237	1261	1345	1445	1279	1370
		130	1337	1361	1445	1545	1379	1470
		140	1437	1461	1545	1645	1479	1570
150		1537	1561	1645	1745	1579	1670	
160		1637	1661	1745	1845	1679	1770	
170		1737	1761	1845	1945	1779	1870	
180		1837	1861	1945	2045	1879	1970	
190	1937	1961	2045	2145	1979	2070		
200	2037	2061	2145	2245	2079	2170		

FIRE STEEL FIXED



EXECUTION STANDARD - FIRE STEEL

- FIRE steel fixed door frame is made of steel plate of thickness 1.5 mm, powder-coated in RAL colours: White (9016), Grey (7047), Brown (8017), White (9003), Graphite (7024)
- complete door frame includes four hinges and a fire-resistant gasket
- gaskets available in three colours – White, Grey, Brown
- reinforcement for door closer
- available sizes – 80', 90', 91', 100', 101', 110'
- EI60 double leaf door frames, other RAL colours as well as other custom features are subject to individual pricing: inwestycje@classen.com.pl

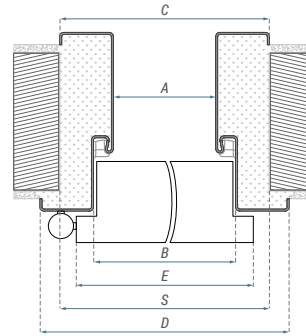
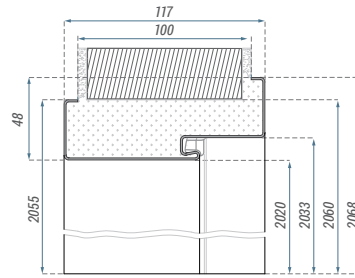
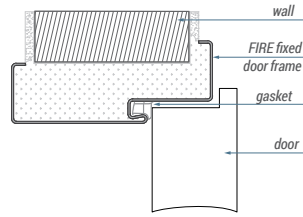

Dimensions of FIRE steel fixed door frame [mm]:

	A	B	C	D	E	S	
SINGLE LEAF	80	800	826	870	896	844	880
	90	900	926	970	996	944	980
	91	912	938	982	1008	956	992
	100	1000	1026	1070	1096	1044	1080
	101	1012	1038	1082	1108	1056	1092
	110	1100	1126	1170	1196	1144	1180
DOUBLE LEAF	100	1035	1061	1105	1131	1079	1115
	110	1135	1161	1205	1231	1179	1215
	120	1235	1261	1305	1331	1279	1315
	130	1335	1361	1405	1431	1379	1415
	140	1435	1461	1505	1531	1479	1515
	150	1535	1561	1605	1631	1579	1615
	160	1635	1661	1705	1731	1679	1715
	170	1735	1761	1805	1831	1779	1815
	180	1835	1861	1905	1931	1879	1915
	190	1935	1961	2005	2031	1979	2015
200	2035	2061	2105	2131	2079	2115	

42 DB MDF FIXED REBATED



EXECUTION STANDARD – 42 DB MFD FIXED

- Door frame is designed for internal rebated fire EI30 42dB and acoustic 42db door leaves. Door frame is made of MDF board, covered with Iridium decors and CPL laminates.
- Available in the following sizes: 60'–90'. Complete door frame includes four hinges and a gasket.
- adjustment set and ranges on page 151

42 DB MDF FIXED ▼

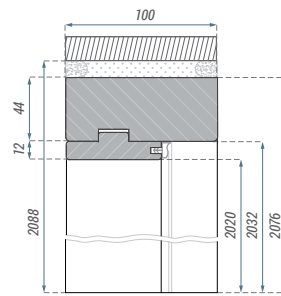

42 DB MDF ADJUSTABLE ▼

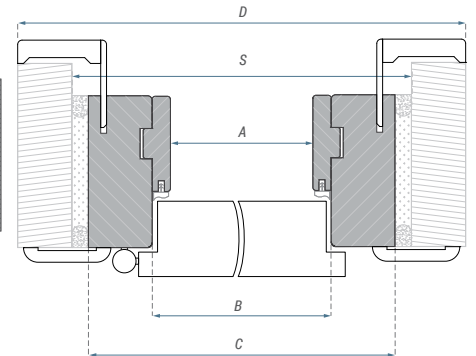
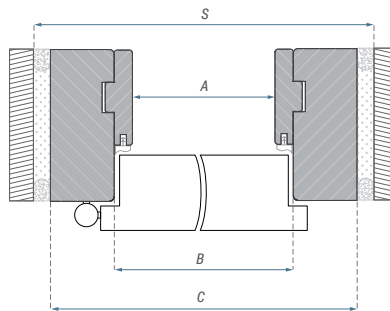
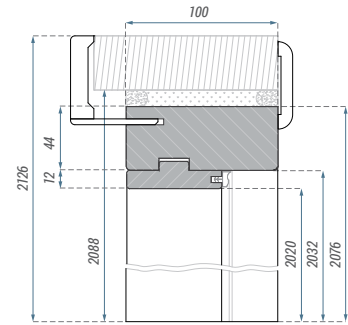

Dimensions of 42dB MDF fixed door frame [mm]:

	A	B	C	D	S
60	602	626	714	814	738
70	702	726	814	914	838
80	802	826	914	1014	938
90	902	926	1014	1114	1038

42 DB MDF FIXED NON-REBATED



EXECUTION STANDARD – 42 DB MFD FIXED NON-REBATED

- Door frame is designed for internal non-rebated fire EI30 42dB and acoustic 42db door leaves. Door frame is made of MDF board, covered with Iridium decors and CPL laminates.
- Available in the following sizes: 60'–90'. Complete door frame includes four hidden hinges and a double set of gaskets. Milling for hidden self-closer (non-extra-cost option) possible.

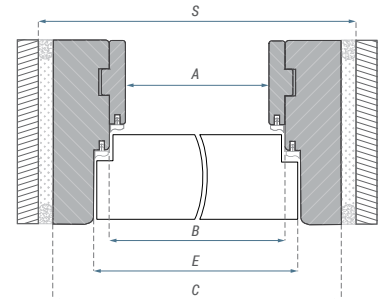
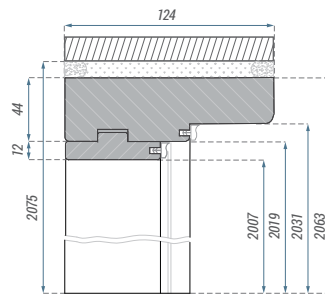

Dimensions of 42dB MDF fixed non-rebated door frame [mm]:

	A	B	C	E	S
60	638	662	750	686	774
70	738	762	850	786	874
80	838	862	950	886	974
90	938	962	1050	986	1074

DOOR FRAME ADJUSTMENT SET

EI30/EI60 FIRE WOODEN, BORD MDF FIXED, 42 DB MDF FIXED

EXECUTION STANDARD

- The set is designed for the extension of the fixed door frame with milling for adjustments in the following door frames: EI30/EI60 FIRE wooden, BORD MDF fixed, 42 dB MDF fixed.
- Available in the following sizes: 80', 90', 91'.
- The set contains the appropriate number of components for the various adjustment ranges, as shown in the technical drawings (see the figures).

COLOURS

Available in decors according to the selected door frame offer.

COMPLETION OF ADJUSTMENT SET FOR INDIVIDUAL RANGES.

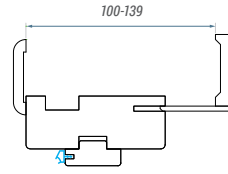

ADJUSTMENT RANGES [MM]	100-139
------------------------	---------

For range 100-139: tongue of the band needs to be cut to size.

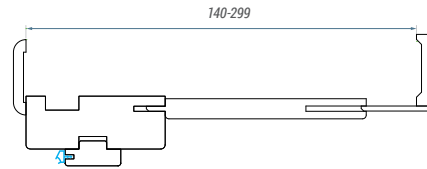

ADJUSTMENT RANGES [MM]	140-179
	180-219
	220-259
	260-299

For range 140-179: tongue of the band needs to be cut to size.

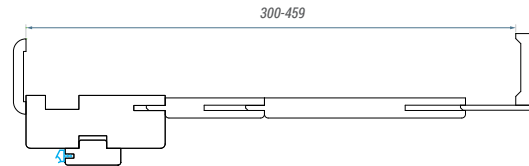

ADJUSTMENT RANGES [MM]	300-339
	340-379
	380-419
	420-459



DOOR FRAME CORE WITH GROOVE FOR ADJUSTMENT BAND



ADJUSTMENT BAND (RIGHT) WITH OVERLAY MOULDING (LEFT)



COMPLETE DOOR FRAME WITH ADJUSTMENT BAND AND OVERLAY MOULDING

THE ABC OF DOORS – information database

CORE



HONEYCOMB filling



PERFORATED CHIPBOARD filling



CLASSEN HARD reinforced construction



CLASSEN HARD EDGE PF construction for PF rebate

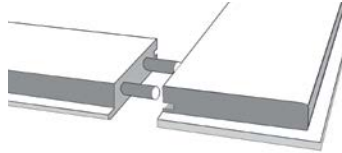

FRAME CONSTRUCTION construction elements connected using mounting pins

REBATED AND NON-REBATED DOOR LEAVES PROFILES



K PROFILE side and top edge of the door leaf



R & R2 PROFILE side and top edge of the door leaf



PF PROFILE postforming only on side edge of the door leaf



B PROFILE non-rebated

VENTILATION



PASS-THROUGH VENTILATION SLEEVES³
Single-coloured PVC, matching door decors



METAL VENTILATION SLEEVES³
satin chrome



PASS-THROUGH VENTILATION GRILLE³
made of plastic, matching door decors



VENTILATION UNDERCUT IN PANEL DOORS¹
undercut 15 mm – for rooms with recuperation
undercut 26 mm – WC for doors 80'-100'
undercut 38 mm – WC for doors 60'-70'

60' – 100'

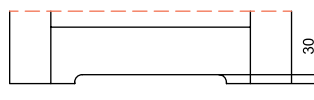

HEIGHT OF VENTILATION UNDERCUT IN FRAME DOORS, FOR WIDTH 60'-100'²⁾

¹ | In line with applicable rules, ventilation area in the door leaf cannot be less than 0.022 m² for air flow. Ventilation grille and ventilation undercut meet these requirements.

Not applicable to Andromeda and Salvano collections, for size 60' and 70'. Undercut 15 mm – for rooms with recuperation.

² | In frame doors with a width of 60', 70', ventilation undercut does not meet the required air throughput in accordance with applicable regulations.

³ | Ventilation sleeves do not meet airflow requirements.

THE ABC OF DOORS – information database

TYPE OF DOOR REBATE

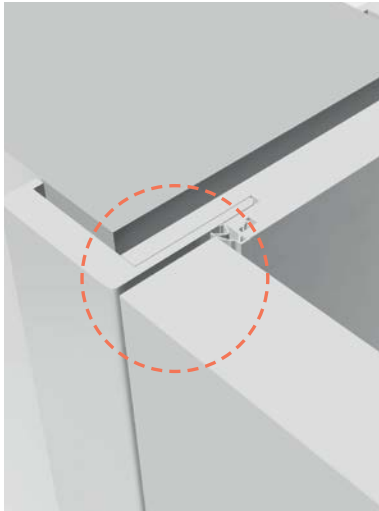

NON-REBATED DOOR



REVERSE DOOR

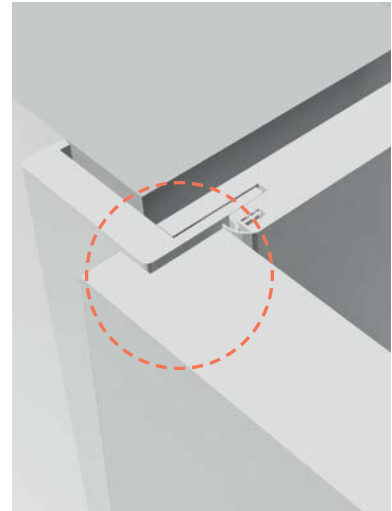

REBATED DOOR



NON-REBATED 3D HINGE



REVERSE 3D HINGE



NON-REBATED / REVERSE STRIKE PLATE



REBATED STRIKE PLATE



REBATED HINGE

DOOR OPENING DIRECTION

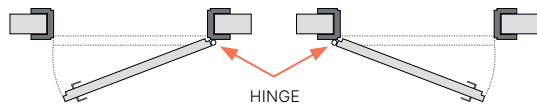

SINGLE LEAF DOOR, **RIGHT**

SINGLE LEAF DOOR, **LEFT**

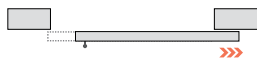

SLIDING DOOR, **RIGHT**

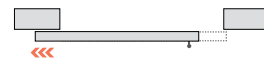

SLIDING DOOR, **LEFT**

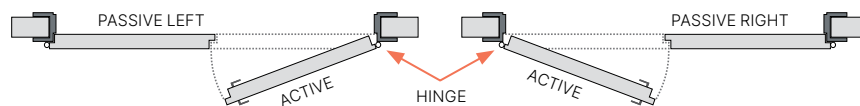

DOUBLE LEAF DOOR, **RIGHT**

DOUBLE LEAF DOOR, **LEFT**

ADDITIONAL ELEMENTS

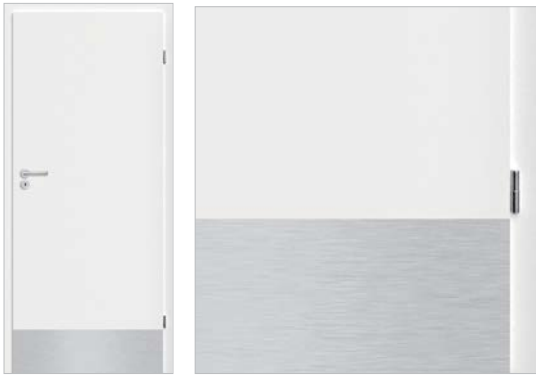

STEEL KICK-PLATE, SOLID
single-sided or double-sided

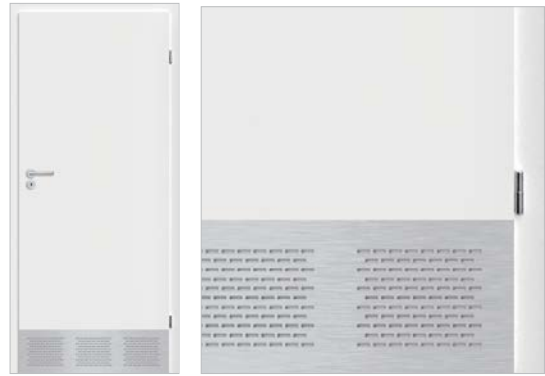

STEEL KICK-PLATE WITH VENTILATION GRILLE
double-sided



STEEL PUSH-PLATE
single-sided or double-sided

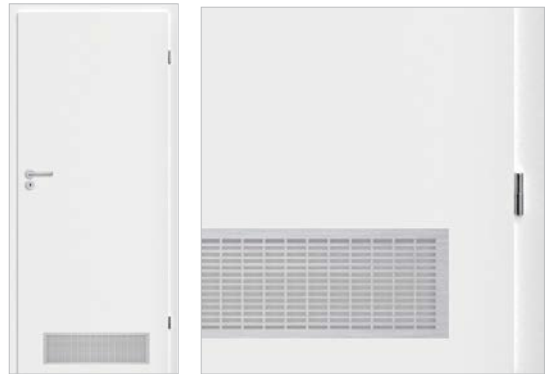

ALUMINUM VENTILATION GRILLE
double-sided



PORTHOLE
internal diameter - 240 mm, frosted or transparent glass

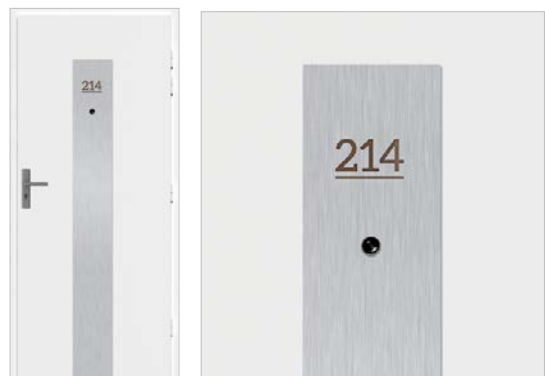

STEEL VERTICAL PUSH-PLATE
with room number

DOOR DIMENSIONS

REBATED / REVERSE DOOR LEAVES DIMENSIONS

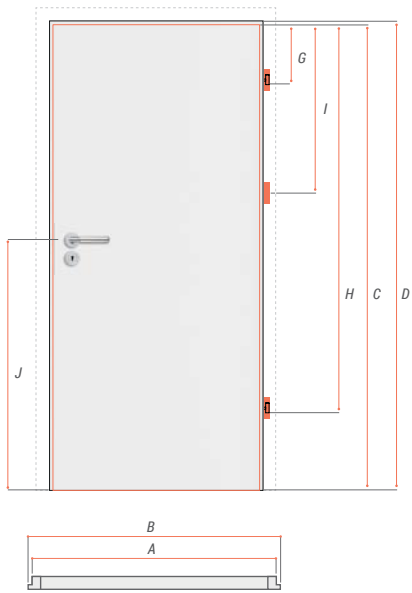

door leaf width	A	B
60	618	644
70	718	744
80	818	844
90	918	944
100	1018	1044
110	1118	1144
120	1218	1244
120	1253	1279
130	1353	1379
140	1453	1479
150	1553	1579
160	1653	1679
170	1753	1779
180	1853	1879
190	1953	1979
200	2053	2079

	dimension (mm)
C	2022
D	2035
E	26
F	13
G	228
H	1708
I	766
J	1112

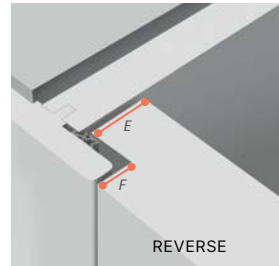
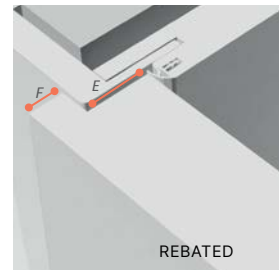

NON-REBATED DOOR LEAVES DIMENSIONS

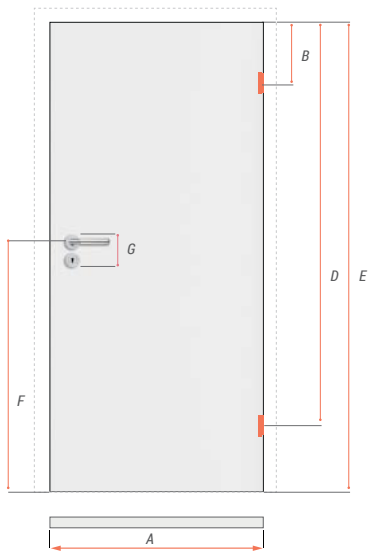

door leaf width	A (mm)
60	618
70	718
80	818
90	918
100	1018

	dimension (mm)
B	275
D	1719
E	2022
F	1110
G	85 - cylinder 90 - WC 90 - key



SLIDING DOOR LEAVES DIMENSIONS

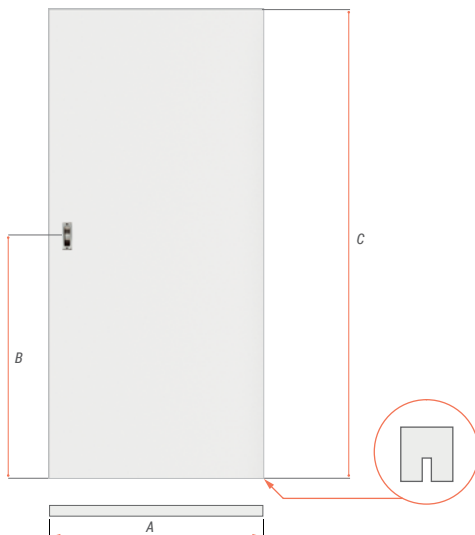

	dimension (mm)
A	644, 744, 844, 944, 1044
B	1110
C	2035

MOULDINGS / RAL COLOURS

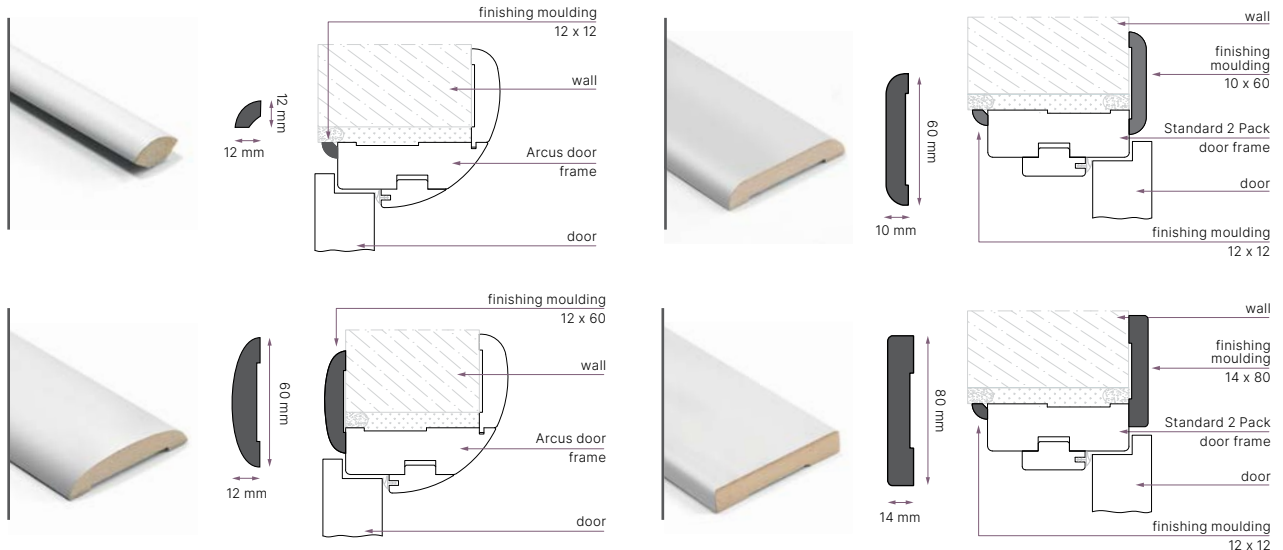

14X80 MM MOULDING AS FINISHING MOULDING FOR DOORS AND AS WALL BASE MOULDING



Application:

Finishing mouldings are used for masking non-finished places of joining the walls and a door frame. 14x80 moulding can be also installed as a wall base moulding. It is possible to install finishing mouldings with small nails.

Colours:

Available in all door decors (except Hamilton Oak, Hickory Oak, and Cashmere decors) and white lacquer.

Packaging:

One package contains three finishing mouldings to be cut to match single or double leaf doors.

For single leaf door: 2x vertical element 2160 mm, 1x beam 1160 mm.

For double leaf door: 2x vertical element 2160 mm, 1x beam 2350 mm..

ADJUSTMENT BAND WITH 60 MM TONGUE



APPLICATION

The band is an optional element designed for adjustable and adjustable 80 door frame.

The band with longer tongue increases the adjustment range by 17 mm. Available in the following width: 60'-90'.

EXTRA-COST OPTIONS

width 100'

¹ | Available in decors as for the non-rebated adjustable 80 door frame (details on page 132).

CROWN

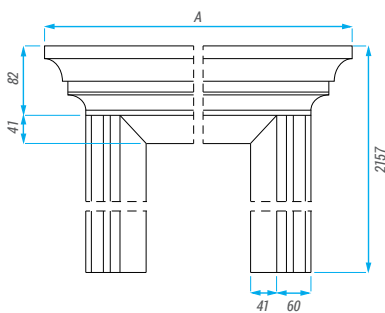

CROWN I

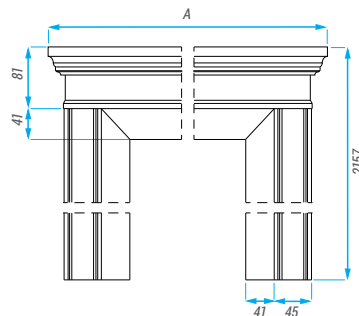

OVERLAY MOULDING II - LN2

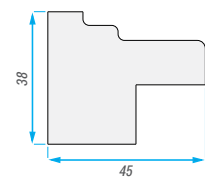
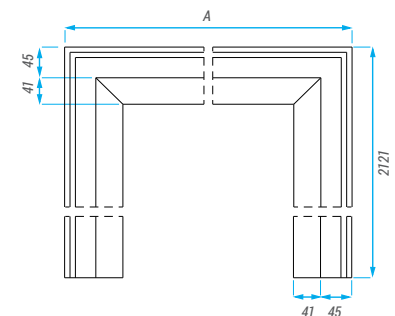

MOULDING PROFILE

CROWN AND OVERLAY MOULDING

Crowns and an overlay moulding are designed for installation with Adjustable and Adjustable Non-rebated door frame (single leaf). Not available with a band 80. Crowns are not adjusted for installation on a door leaf with a band 80 mm. Surface finishing: PU lacquered.

Lacquer from RAL palette as an extra-cost option. Minimum order quantity - 3 sets, door leaf + door frame + crown.

Table of optional finishes in RAL colours on page 171

Adjustable door frame	dimension A (mm)		
	Crown	Crown I	Overlay moulding LN2
60	900	843	800
70	1000	943	900
80	1100	1043	1000
90	1200	1143	1100
100	1300	1243	1200

ACCESSORIES

VENTILATION

PVC VENTILATION SLEEVES (DIAMETER: 53MM) MATCHING THE COLOUR OF THE DOOR LEAF VENEER:



WHITE



LIGHT GREY



LIGHT BEIGE



DARK BEIGE



BROWN



DARK BROWN



GRAPHITE

VENTILATION GRILLES



GRILLE FOR TECHNICAL DOORS aluminium



WHITE plastic



LIGHT BEIGE plastic



DARK BEIGE plastic



GREY plastic



ORANGE plastic



DARK BROWN plastic



GRAPHITE plastic

LOCKS



REBATED DOOR LEAVES LOCK left and right version key / cylinder / WC (4x4)



REBATED DOOR LEAVES LOCK black, left and right version key / cylinder / WC (4x4)



STRIKE PLATE black, for rebated doors



REVERSE ELECTRIC STRIKE



AVERSE ELECTRIC STRIKE



FIRE AVERSE ELECTRIC STRIKE



MAGNETIC LOCK for non-rebated doors key / cylinder / WC (6x6)



MAGNETIC LOCK black, for non-rebated doors key / cylinder / WC (6x6)



STRIKE PLATE black, for non-rebated doors



HOOK LOCK for sliding doors key / WC lock



DEADBOLT LOCK bottom, Bord left / right



DEADBOLT LOCK top, Bord



FIRE LOCK



LOCK CYLINDER Designed for cylinder locks, 26/36 mm



SET OF LOCK CYLINDERS Designed for cylinder locks, 26x40 class II (BORD W3)

ACCESSORIES

HINGEY



3D HINGE
for non-rebated doors
nickel or titanium



REVERSE HINGE
for reverse doors
nickel or titanium



DOOR FRAME HINGE



PANEL DOOR HINGE



GUARD HINGE
steel door frame



EXACTA FIRE HINGE
door frame steel part

HINGES / DOOR STOPS



EXACTA FIRE HINGE
door frame wooden part



EXACTA FIRE HINGE
door top part



WALL DOOR STOP
nickel cone



WALL DOOR STOP
nickel square



FLOOR DOOR STOP
nickel spherical



FLOOR DOOR STOP
bronze spherical

PVC ROUND FLUSH PULL HANDLES

ROUND (DIAMETER: 53 MM) – FOR SLIDING DOORS



WHITE



SILVER



GOLDEN



BEIGE



BROWN

DOOR CLOSERS



DC140 SURFACE MOUNTED DOOR CLOSER
with standard arm for FIRE door



DC135 DOOR CLOSER
with sliding rail for FIRE door



DOOR CLOSER
for sliding doors system

OTHR ACCESSORIES



PEEPHOLE
nickel, grafiatto bronze



PEEPHOLE
black



DOOR PULL HANDLE
for sliding doors,
black



DOOR PULL HANDLE
for sliding doors,
steel nickel



HINGE PVC COVERS
for panel doors, diameters: 3.5 or 15 mm.
Colours: white, satin, gold, black

HANDLES

NEW!

DIVO Q - black



HANDLE
with a short escutcheon plate



gold



chrome



satin gold



satin chrome

CRUZ Q - black



HANDLE
with a short escutcheon plate



brushed chrome



anthracite

EUFORIO Q - black



HANDLE
with a short escutcheon plate

EUFORIO Q - brushed chrome



HANDLE
with a short escutcheon plate

VINCI - satin gold



HANDLE
with a short escutcheon plate



gold



chrome



black



satin copper



brushed chrome



anthracite

MILA - brushed chrome



HANDLE
with a short escutcheon plate



anthracite



black

NESH - chrome



HANDLE with a short escutcheon plate

NESH - black



HANDLE with a short escutcheon plate

CASCADA - cuero



HANDLE with a short escutcheon plate



black



gold



chrome

DIVO - chrome



HANDLE with a short escutcheon plate



gold



satin chrome



black

Q SQUARE ROSETTES



key rosette, RK



cylinder rosette, RP



WC rosette



black



satin chrome



gold



anthracite



brushed chrome



satin gold



chrome

ROUND ROSETTES



key rosette, RK



cylinder rosette, RP



WC rosette



black



satin chrome



gold



anthracite



brushed chrome



satin gold



chrome



cuero



satin copper

HANDLES

TIPO QR black



HANDLE
with a short escutcheon plate



standard rosette



cylinder rosette



WC rosette



black

TIPO QR nickel



HANDLE
with a short escutcheon plate



standard rosette



cylinder rosette



WC rosette



nickel

NOVAR brass



HANDLE
with a short escutcheon plate



standard rosette



cylinder rosette



WC rosette



brass

NOVAR nickel



HANDLE
with a short escutcheon plate



standard rosette



cylinder rosette



WC rosette



nickel

HANDLES

DIANA QR satin chrome



HANDLE
with a short escutcheon plate



standard rosette



cylinder rosette



WC rosette



satin chrome

PRADO satin steel



HANDLE
with a short escutcheon plate



standard rosette



cylinder rosette



WC rosette



satin steel

ROMANA grafiatto bronze chrome / nickel



HANDLE
with a short escutcheon plate



standard rosette



cylinder rosette



WC rosette



chrome /
nickel



grafiatto bronze

ANTI-SLAM HANDLE stainless steel



HANDLE
with a short escutcheon plate



standard rosette



cylinder rosette



WC rosette



stainless
steel

OLARIX KNOB-HANDLE, class III – for doors with one-sided access control black, stainless steel



HANDLE
left / right



HANDLE
universal L/R



black



stainless
steel

HANDLES

QUBIK QR

black mat,
nickel,
titanium



HANDLE
with a short escutcheon plate



standard rosette



cylinder rosette



WC rosette



black
mat



nickel



titanium

SIGMA QR

inox stainless steel



HANDLE
with a short escutcheon plate



standard rosette



cylinder rosette



WC rosette



inox stainless
steel

FOKUS QR

black,
titanium



HANDLE
with a short escutcheon plate



standard rosette



cylinder rosette



WC rosette



black



titanium

NOVA

nickel



HANDLE
with a long escutcheon
plate



standard rosette



cylinder rosette



WC rosette



nickel

NOVA

brass



HANDLE
with a long escutcheon
plate



standard rosette



cylinder rosette



WC rosette



brass

HANDLES

ALMA ECO
grafiatto bronze,
nickel

HANDLE
with a long escutcheon
plate



standard rosette



cylinder rosette



WC rosette

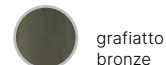

grafiatto
bronze



nickel

SHARK
black,
inox



HANDLE
with a long escutcheon plate,
spacing 72 mm, upper rosette,
short..

ESCUTCHEON PLATE

For W46 Bord door
(multipoint lock)
and FIRE door.



HANDLE
with a long escutcheon plate,
spacing 90 mm, upper rosette,
long.

ESCUTCHEON PLATE

For B40, B46 Bord door
(deadbolt lock).



inox



black

NEW!

NOVAX class II / for: Bord W3, Bord W46 W1, Bord W46 W2 doors
black, inox

HANDLE
with a long escutcheon
plate, spacing 72 mm,
upper rosette, short.



rosette for upper
lock, cylinder



inox



black



VENEER

PRIMO

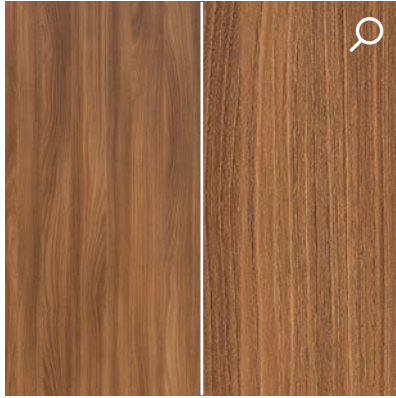

ACACIA ST

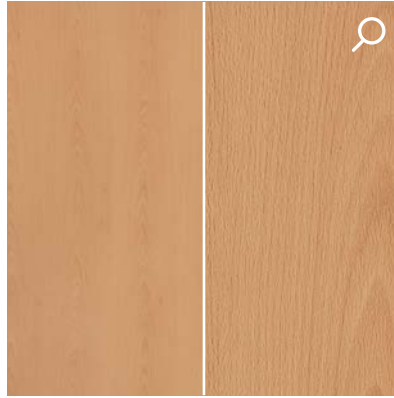

BEECH

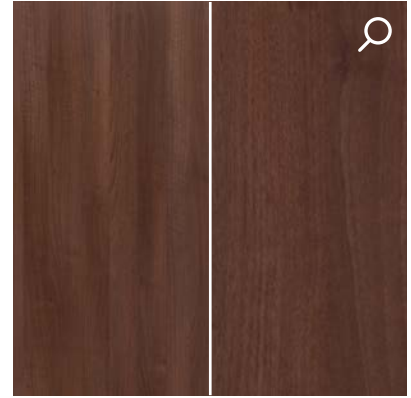

WALNUT

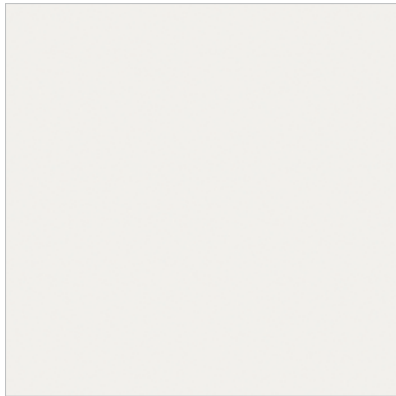

WHITE



GREY MATT

3D LOOK

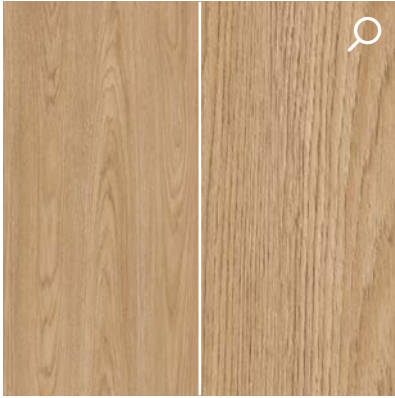

TOCANTIS OAK

NEW!



GESSATO OAK



CLEVELAND OAK

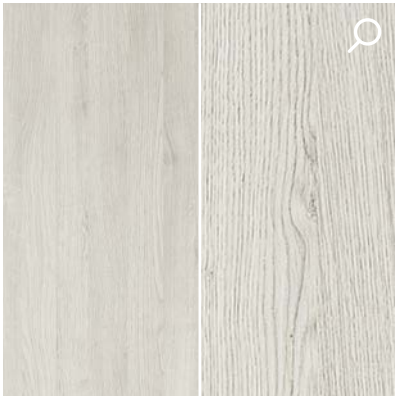

GREY OAK

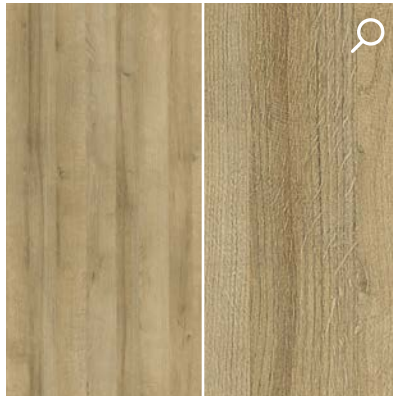

RIVIERA OAK

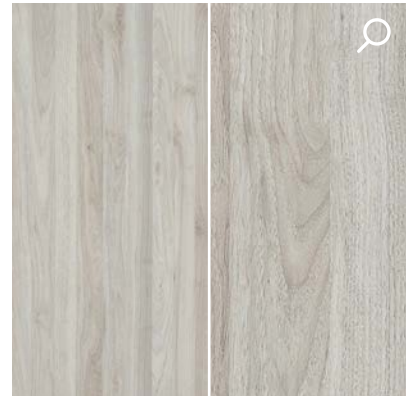

COLOMBIA LIGHT WALNUT

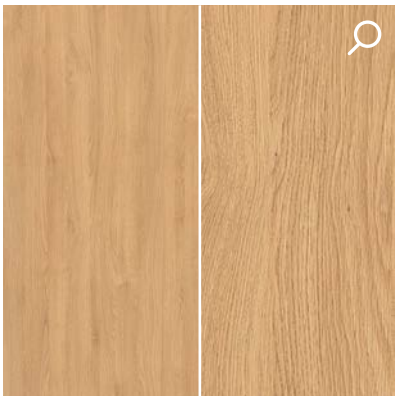

OILED OAK

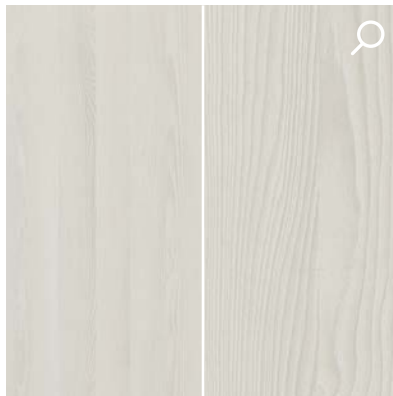

WHITE ASH

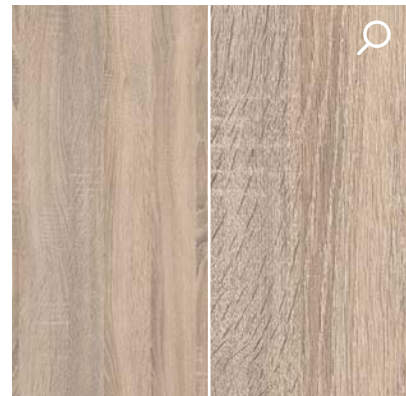

SONOMA OAK

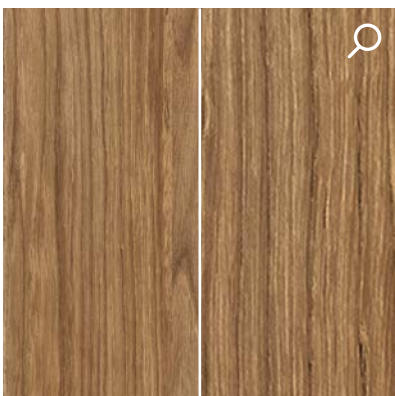

HONEY CATANIA

VENEER

IRIDIUM

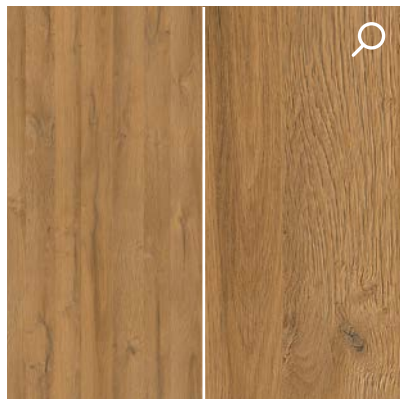

GRANDSON OAK

NEW!

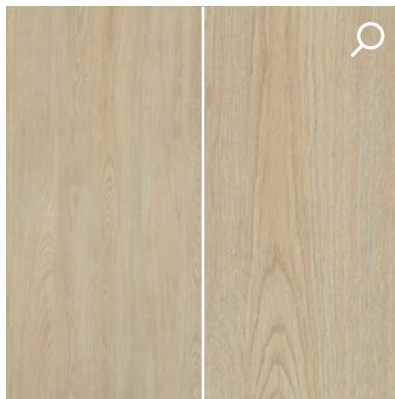

MARRONE OAK

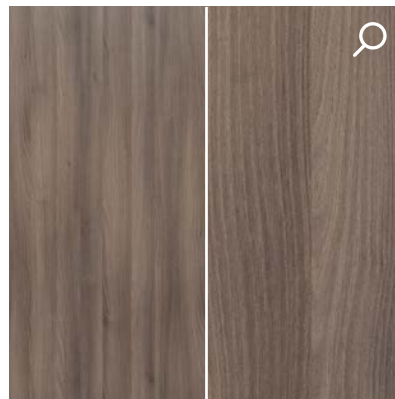

GRAPHITE ASH

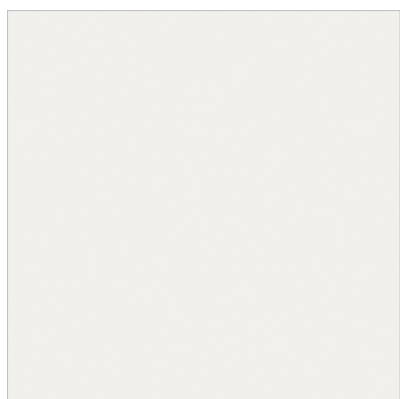

UNI WHITE

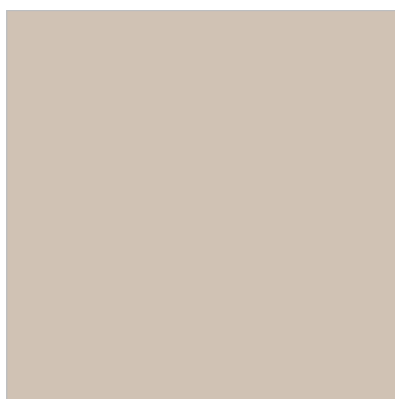

UNI CASHMERE

NEW!



UNI GREEN

NEW!



UNI GRAPHITE

NEW!

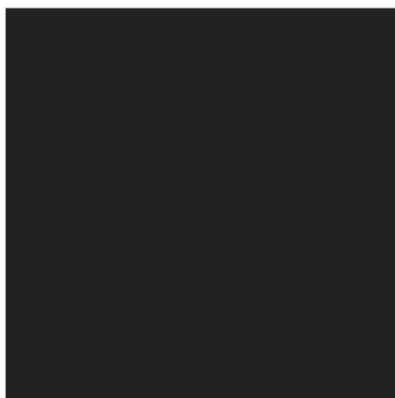

UNI BLACK

CPL



HICKORY OAK

NEW!



HAMILTON OAK VERTICAL

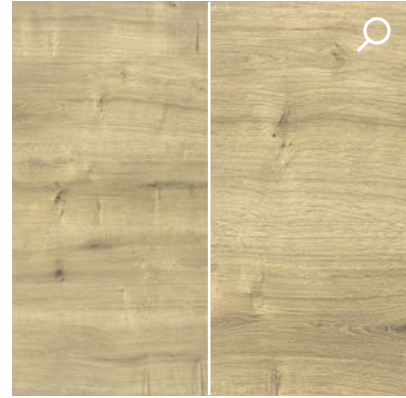

HAMILTON OAK HORIZONTAL

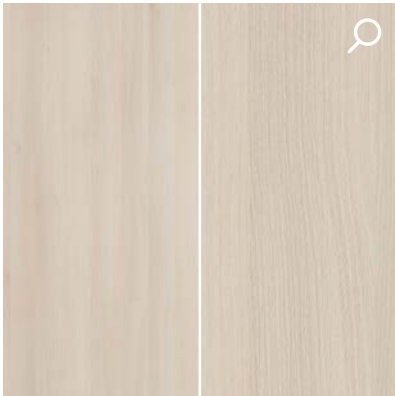

LIGHT ACACIA

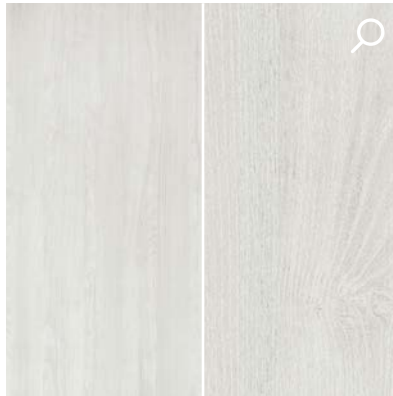

NORWEGIAN ASH

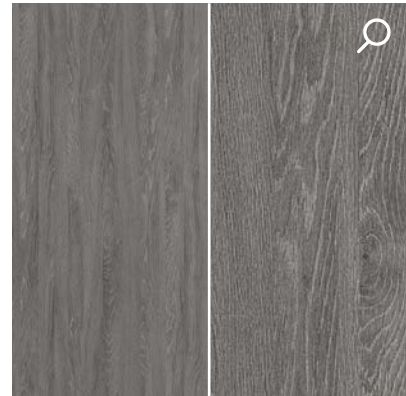

GRIGIO OAK

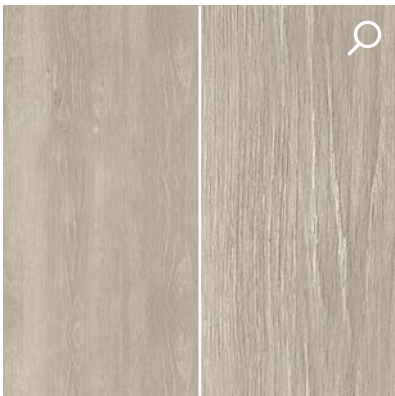

KENDAL OAK

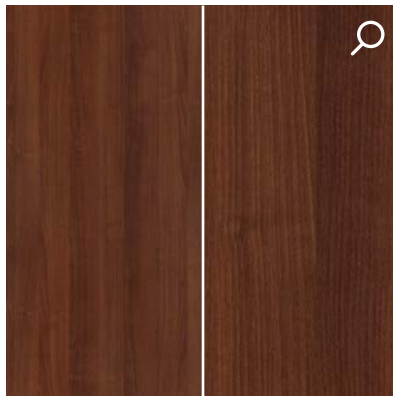

ITALIAN WALNUT

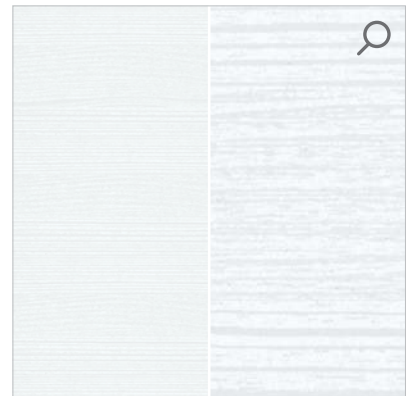

WHITE WITH HORIZONTAL STRUCTUR

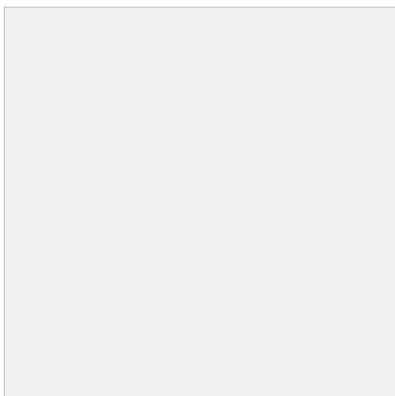

RAL 9003 WHITE



CASHMERE



RAL 7024 GRAPHITE

VENEER / LACQUER

HPL



RAL 7024 GRAPHITE

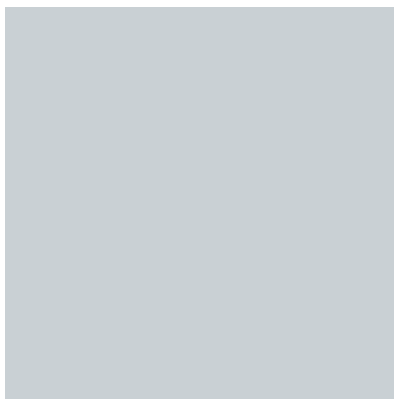

RAL 7047 GREY

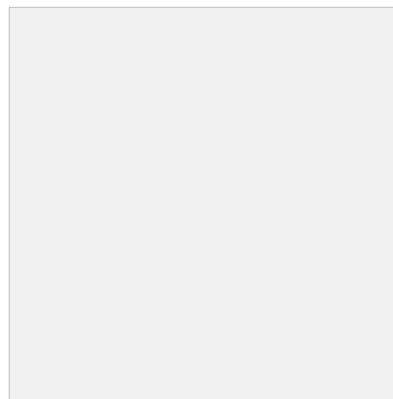

RAL 9003 WHITE

LACQUER

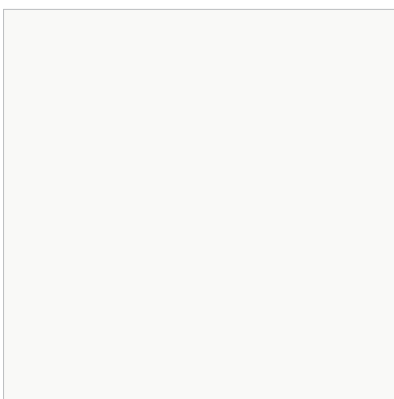

WHITE - LACQUERED, SIMILAR TO RAL 9003



WHITE - LACQUERED WITH STRUCTURE

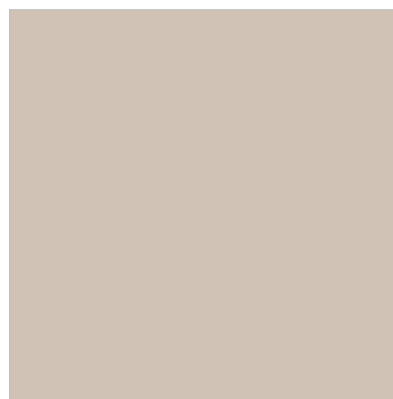

CASHMERE - LACQUERED, SIMILAR TO NCS 2005



GREY - LACQUERED, SIMILAR TO RAL 7004



BLACK - LACQUERED, SIMILAR TO RAL 9005



CHOOSE COLOUR
WHICH
SUITS YOU BEST

RAL COLOURS

RAL COLOURS
EXTRA-COST OPTIONS: FOR DOORS, ADJUSTABLE DOOR FRAME, STANDARD 2-PACK, FINISHING MOULDINGS
 Minimum order quantity - 3 sets

GROUP I	1013, 1014, 1015, 7004, 7032, 7035, 7038, 7040, 7044, 7047, 9001, 9002, 9003, 9010, 9016, NCS 2005
GROUP II	1000, 1001, 1002, 1011, 1019, 1020, 1024, 3009, 3012, 3015, 3034, 5012, 5014, 5015, 5018, 6021, 6027, 6034, 7000, 7002, 7003, 7005, 7006, 7009, 7023, 7030, 7031, 7034, 7036, 7037, 7039, 7042, 7045, 7046, 8002, 8017, 8024, 8025, 9011
GROUP III	1003, 1004, 1005, 1012, 1017, 1034, 3000, 3014, 3017, 3018, 3022, 4001, 4002, 4003, 4005, 4006, 4008, 4009, 4010, 5000, 5001, 5002, 5003, 5005, 5007, 5008, 5009, 5011, 5013, 5017, 5019, 5020, 5021, 5022, 5023, 6000, 6003, 6006, 6008, 6010, 6011, 6012, 6014, 6015, 6016, 6017, 6020, 6022, 6024, 6026, 6028, 6032, 6033, 7008, 7013, 7024, 7026, 8000, 8001, 8003, 8004, 8007, 8008, 8011, 8014, 8019, 8022, 8023, 9017
GROUP IV	1006, 1007, 1016, 1018, 1021, 1023, 1027, 1028, 1032, 1033, 2000, 2001, 2002, 2003, 2008, 2009, 2010, 2011, 2012, 3001, 3002, 3003, 3004, 3005, 3007, 3011, 3013, 3016, 3020, 3027, 3031, 4004, 4007, 5004, 6001, 6002, 6004, 6007, 6009, 6018, 6025, 7016, 8012, 9005

HPL UNI DECORS

Available upon individual enquiries. Brushed aluminium coloured rebate as standard.
Details in the Customer Service department.

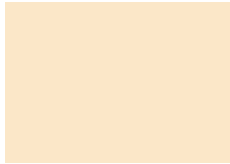

Cotton
U113 – NCS S0907-Y30R



Vibrant Yellow
U114 – NCS S1060-Y10R



Citrus Yellow
U131 – NCS S0560-G90Y



Sand Beige
U156 – NCS S1505-Y50R



Curry Yellow
U163 – NCS S2060-Y10R

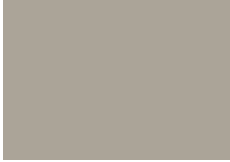

Silicon Grey
U201 – NCS S3502-Y

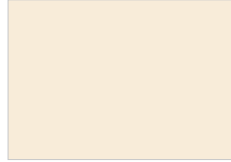

Came Beige
U216 – NCS S0502-Y50R



Burgundy
U311 – NCS S5040-R



Chinese Red
U321 – NCS S1580-Y90R



Chilli Red
U323 – NCS S3060-R

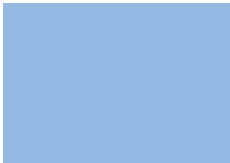

Blue Horizon
U522 – NCS S1030-R80B



Faience Blue
U525 – NCS S3060-R90B



Indigo Blue
U599 – NCS S8505-R80B



Lime Green
U630 – NCS S1060-G40Y



Kiwi Green
U626 – NCS S3050-G40Y



Niagara Green
U646 – NCS S5030-B30G



Cashmere
U702 – NCS S2005-Y60R

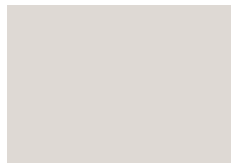

Silky Grey
U707 – NCS S1500-N



Light Grey
U708 – NCS S2000-N



Stone Grey
U727 – NCS S4005-Y50R



Dust Grey
U732 – NCS S5000-N



Lava Grey
U741 – NCS S7005-Y20R



Taupe Grey
U750 – NCS S2005-Y20R



Pearl Grey
U763 – NCS S2500-N



Cubanite Grey
U767 – NCS S6005-Y20R

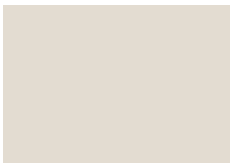

White Grey
U775 – NCS S1000-N



Arctic Grey
U788 – NCS S4500-N



Velvet Black
U899 – NCS S8500-N



Grey Onyx
U960 – NCS S6500-N

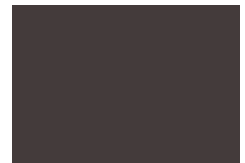

Graphite Grey
U961 – NCS S8000-N



Diamond Grey
U963 – NCS S7500-N

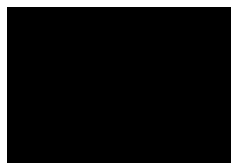

Black
U999 – NCS S9000-N



Platinum White
W980 – NCS S0300-N



Solid Premium White
W1001 – NCS S0500-N

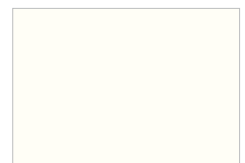

Alpine White
W1100 – NCS S0502-R50B

HPL WOOD DECORS

Available upon individual enquiries. Brushed aluminium coloured rebate as standard.
Details in the Customer Service department.



Light Grey Chicago Concrete
F186



Dark Grey Chicago Concrete
F187



Inox Metallic
F500



Silver Chromix
F638

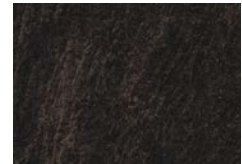

Cupria Slate
F237



Natural Bardolino Oak
H1145



Sevilla Ash
H1223



Natural Sheffield Acacia
H1242



Navarra Ash
H1250



Light Lakeland Acacia
H1277



Brown Belmont Oak
H1303



Natural Wild Oak
H1318



Truffle Brown Denver Oak
H1399



Lincoln Walnut
H1714



Parona Walnut
H1715



Willow Beech
H1910



Grey Corbridge Oak
H3156



Vicenza Oak
H3157

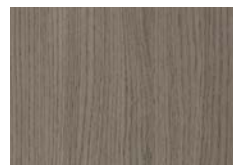

Grey Vicenza Oak
H3158



Light Vicenza Oak
H3165



Natural Kendal Oak
H3170



Oiled Kendal Oak
H3171



Anthracite Finline Metallic
H3190



White Finline
H3195

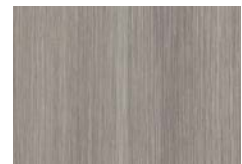

Medium Grey Finline
H3197



Natural Hamilton Oak
H3303



Natural Nebraska Oak
H3331



Grey Nebraska Oak
H3332



Natural Corbridge Oak
H3395



White Aland Pine
H3430



Polar Aland Pine
H3433



White Fleetwood
H3450



Natural Pacific Walnut
H3700

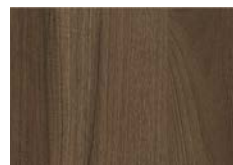

Tobacco Pacific Walnut
H3702

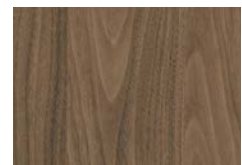

Natural Pacific Walnut
H3710

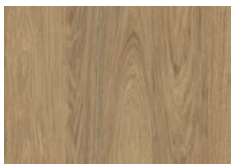

Natural Hickory
H3730



Natural Dijon Walnut
H3734



Natural Mandal Maple
H3840

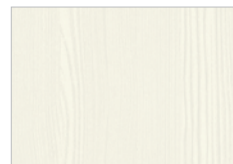

Premium White ST19
W1000_ST19



Classen-Pol S.A.
ul. Wyzwolenia,
44-292 Zwonowice k. Rybnika
tel: +48 (32) 429 20 00

e-mail: biuro@classen.com.pl

www.classen.pl

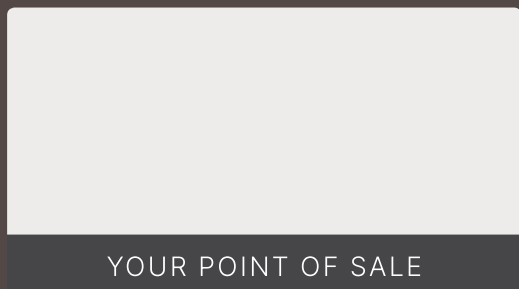

The catalogue does not constitute an offer within the meaning of commercial law. Classen-Pol S.A. reserves the right to change and improve the products presented in this publication without prior notice. Information contained in this catalogue is correct at the time of publishing.

Colours presented in this catalogue may differ from the products that are on sale.



Art. no. 60010455 | CLASS. 06.2025/EN

